



ACCELERATED INFRASTRUCTURE FOR THE AI ERA



Ashish Saran

Senior Vice President, Investor Relations

Agenda



Matt Murphy
Chairman and Chief Executive Officer



Loi Nguyen
EVP and GM, Cloud Optics



Achyut Shah
SVP and GM, Connectivity



Nick Kucharewski
SVP and GM, Network Switching



Raghiv Hussain
President, Products and Technology

Q&A

Forward-looking statements

Except for statements of historical fact, this presentation contains forward-looking statements (within the meaning of the federal securities laws) including, but not limited to, statements related to market trends and to the company's business and operations, business opportunities, growth strategy and expectations, and financial targets and plans, that involve risks and uncertainties. Words such as "anticipates," "expects," "intends," "plans," "projects," "believes," "seeks," "estimates," "can," "may," "will," "would" and similar expressions identify such forward-looking statements. These statements are not guarantees of results and should not be considered as an indication of future activity or future performance. Actual events or results may differ materially from those described in this presentation due to a number of risks and uncertainties.

For factors that could cause Marvell's results to vary from expectations, please see the risk factors identified in Marvell's Annual Report on Form 10-K for the fiscal year ended February 3, 2024, as filed with the SEC on March 13, 2024, and other factors detailed from time to time in Marvell's filings with the SEC. The forward-looking statements in this presentation speak only as of the date of this presentation and Marvell undertakes no obligation to revise or update publicly any forward-looking statements.

Non-GAAP financial measures

- During this presentation, we may refer to certain financial measures on a U.S. non-GAAP basis.
- We believe that the presentation of non-GAAP financial measures provides important supplemental information to management and investors regarding financial and business trends relating to our financial condition and results of operations.
- While we use non-GAAP financial measures as a tool to enhance our understanding of certain aspects of our financial performance, we do not consider these measures to be a substitute for, or superior to, the information provided by GAAP financial measures.
- A reconciliation in accordance with SEC Regulation G for non-GAAP financial measures is available in the Investor Relations section of our website at <https://www.marvell.com>.



Matt Murphy

Chairman and Chief Executive Officer



>\$2 trillion

Accelerating AI revenue for Marvell

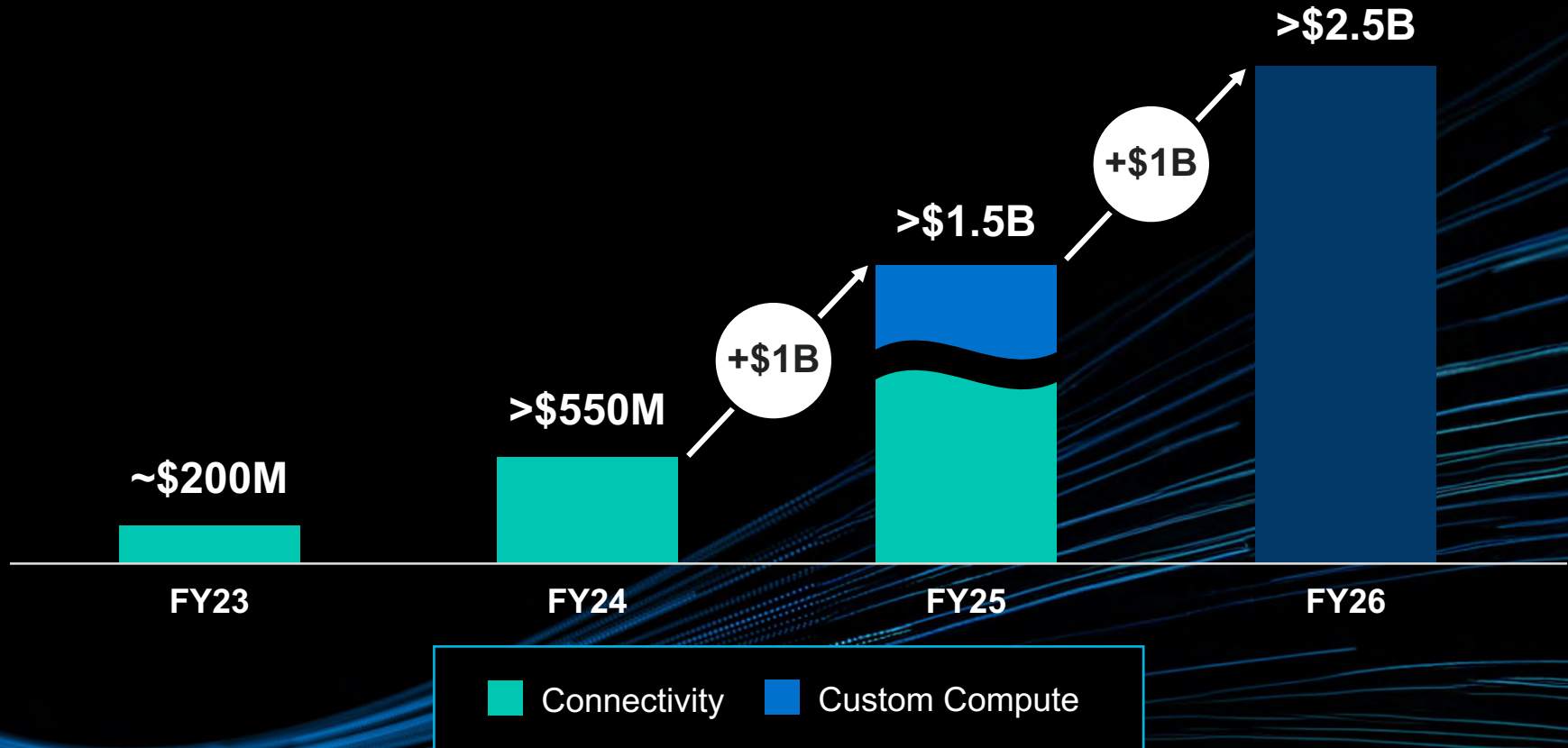



Accelerated computing relies on
Accelerated Infrastructure

AI is the ultimate **data infrastructure** application

We develop and deliver semiconductor solutions that **move**, **store**, **process** and **secure** the world's **data** faster and more reliably than anyone else.



Compute



Connectivity



Storage

What is accelerated infrastructure?

Compute

XPU

Connectivity

Switching

Interconnect

Storage

Controllers

Marvell accelerated infrastructure

Compute

XPU

Connectivity

Switching

Interconnect

Storage



Controllers

Marvell accelerated infrastructure

Compute

XPU

Connectivity

Switching



Interconnect

Storage



Controllers

Marvell accelerated infrastructure

Compute

XPU

Connectivity



Ethernet switch



Interconnect

Storage



Controllers

Marvell accelerated infrastructure

Compute



Custom compute

Connectivity



Ethernet switch



Interconnect

Storage



Controllers

Interconnect in accelerated infrastructure

- Custom compute
- Ethernet switch
- Interconnect**

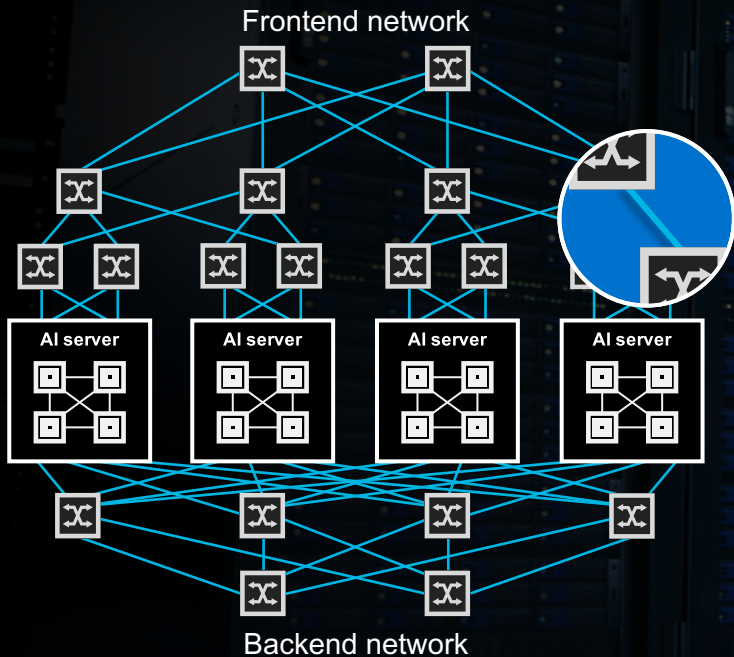

Connectivity foundational to accelerated computing

Custom compute

Ethernet switch

Interconnect

General purpose

One workload,
one processor



Accelerated

One workload,
many connected processors

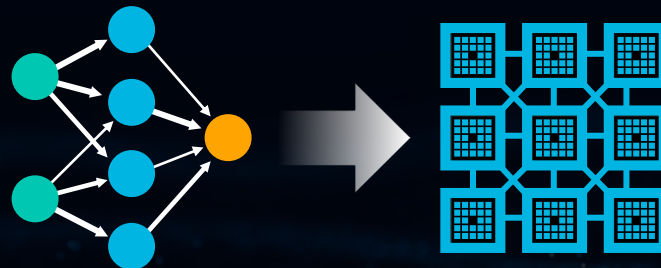

Simple math of accelerated connectivity

Custom compute

Ethernet switch

Interconnect

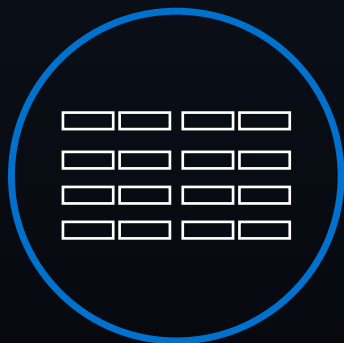

Number of ports

X



Port speed

=



Network hypergrowth

Massive TAM expansion

Investing to gain share in Ethernet switching for AI

Custom compute

Ethernet switch

Interconnect

Data center
switching investment

>2.5X

At Innovium close

FY25

12.8 T

51.2 T



AI disruption creating new entry points

Partnering with customers for custom compute

2018 Investor Day

Emerging compute architectures for the Data Center

SECURITY AND NETWORK OFFLOAD



ARM SERVERS FOR CLOUD APPLICATIONS



ARTIFICIAL INTELLIGENCE



2021 Investor Day

Cloud-optimized silicon

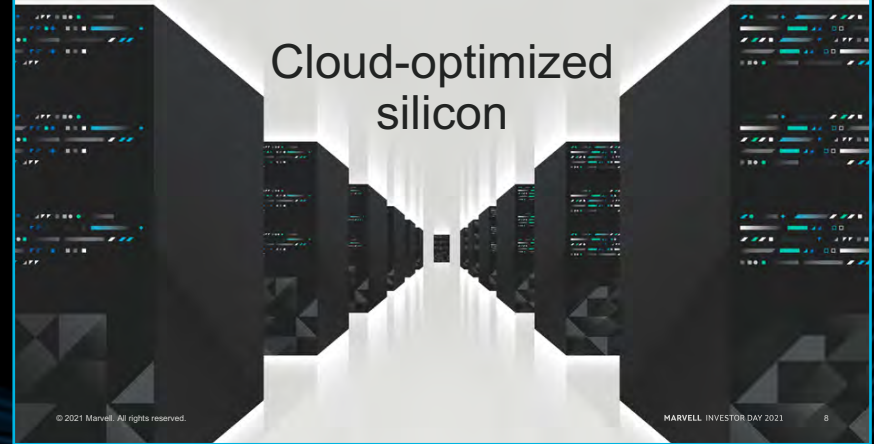

Multiple custom compute opportunities

Accelerated compute for AI

XPU



CPU



Custom compute

Security



NIC / DPU



Arm compute



Storage



Video



CXL



Simple math of custom compute

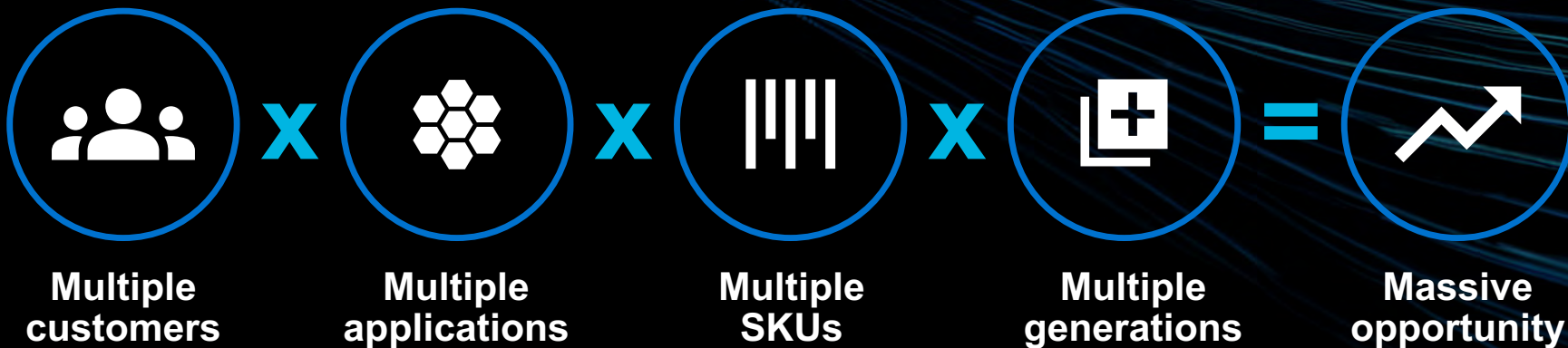

Massive TAM expansion

Expanding our AI customer base

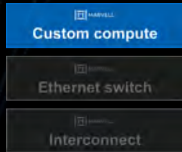

Customer A

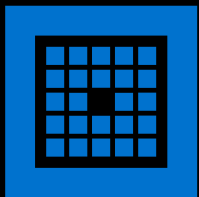

AI training
accelerator

Ramping now

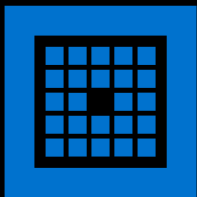

AI inference
accelerator

CY2025 ramp
NEW!

Customer B

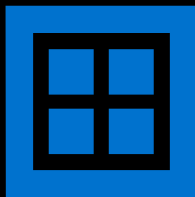

Arm
CPU

Ramping now

NEW! Customer C



AI accelerator

CY2026 ramp

AI compute: 3 out of 4 U.S. hyperscale operators

Investing for success

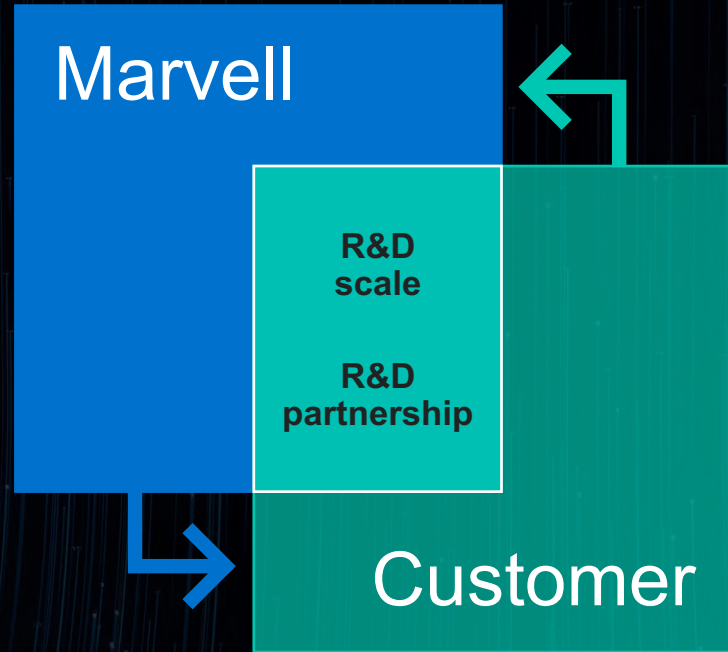

Partnering and co-investing with customers

Marvell accelerated infrastructure platform

Process node

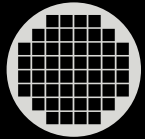

5nm

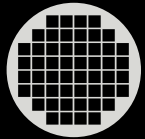

3nm

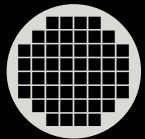

2nm

IP

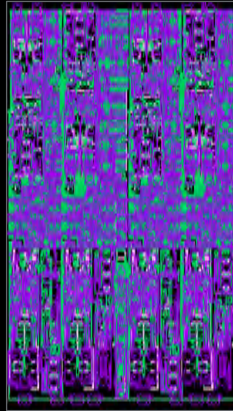

SerDes

Packaging

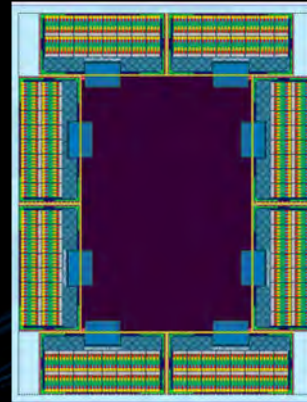

2.5D/3D

Expertise

- Processor
- Large silicon
- Multi-chip
- Chiplet
- High bandwidth
- Networking
- SiPho

2023 data center infrastructure market

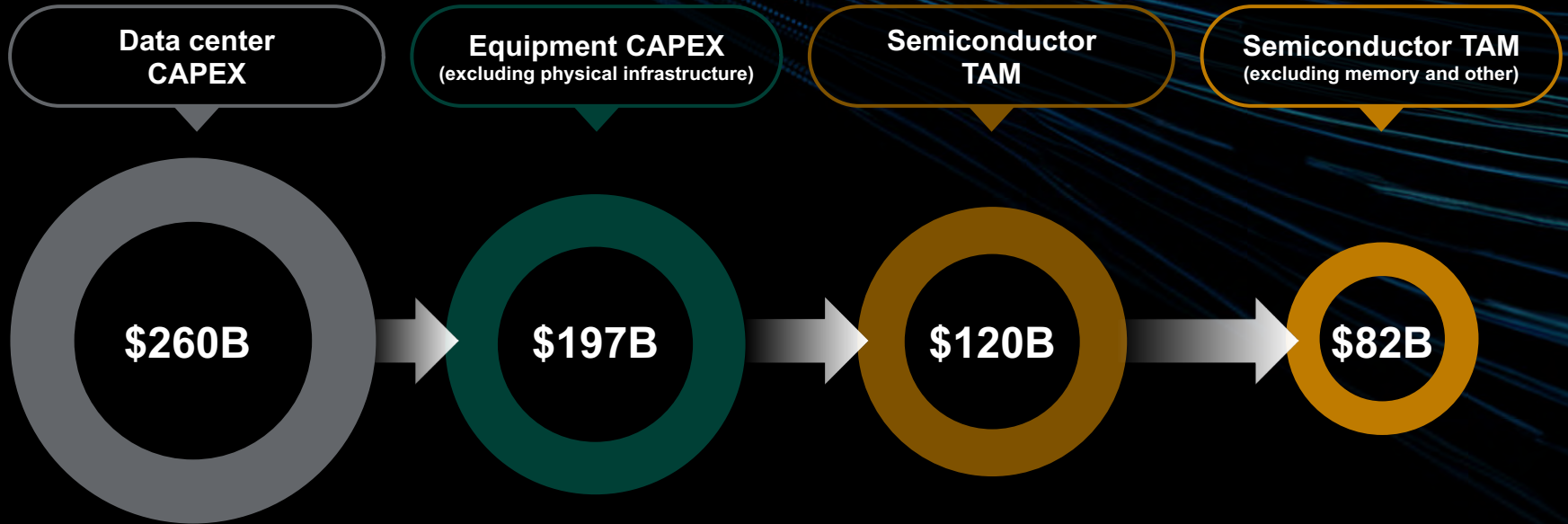

Source: 650 Group, CignalAI, Dell'Oro, LightCounting, and Marvell estimates

2023 data center semiconductor TAM

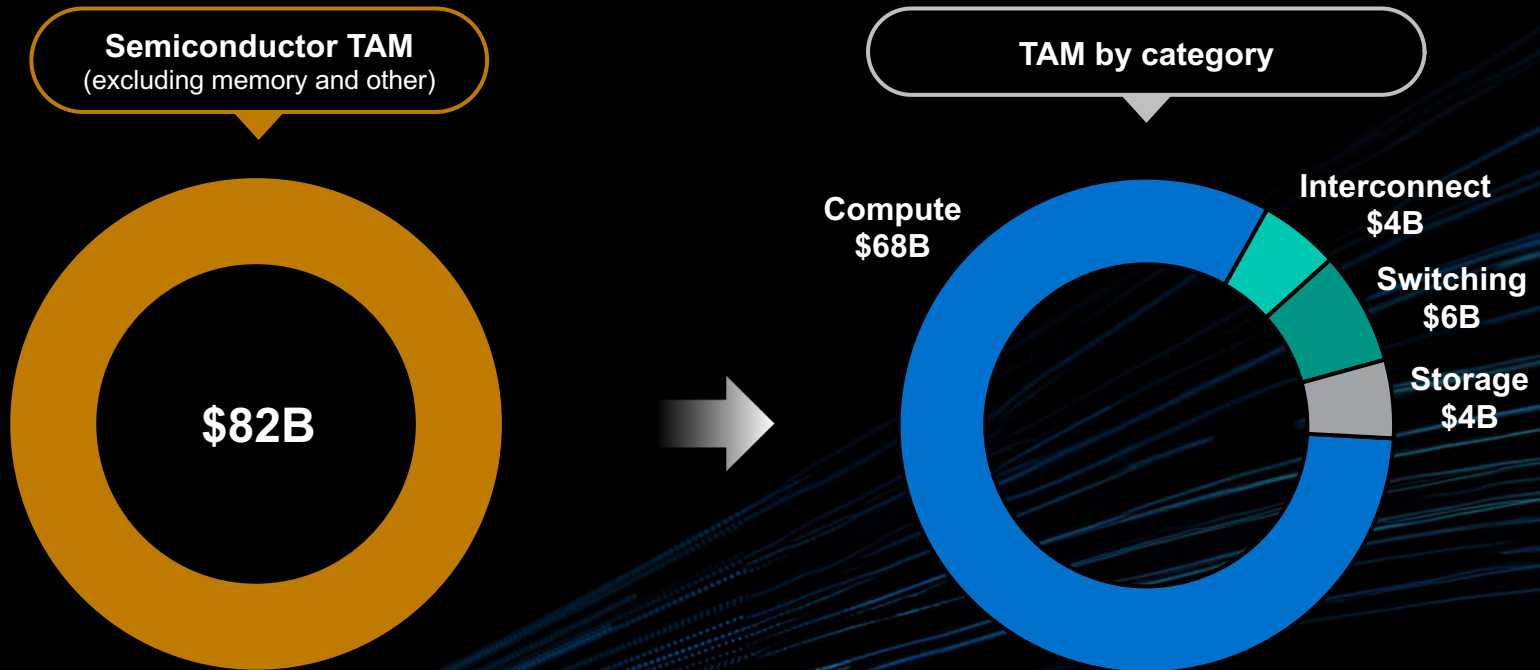

Source: 650 Group, CignalAI, Dell'Oro, LightCounting, and Marvell estimates

Data center **accelerated compute** opportunity

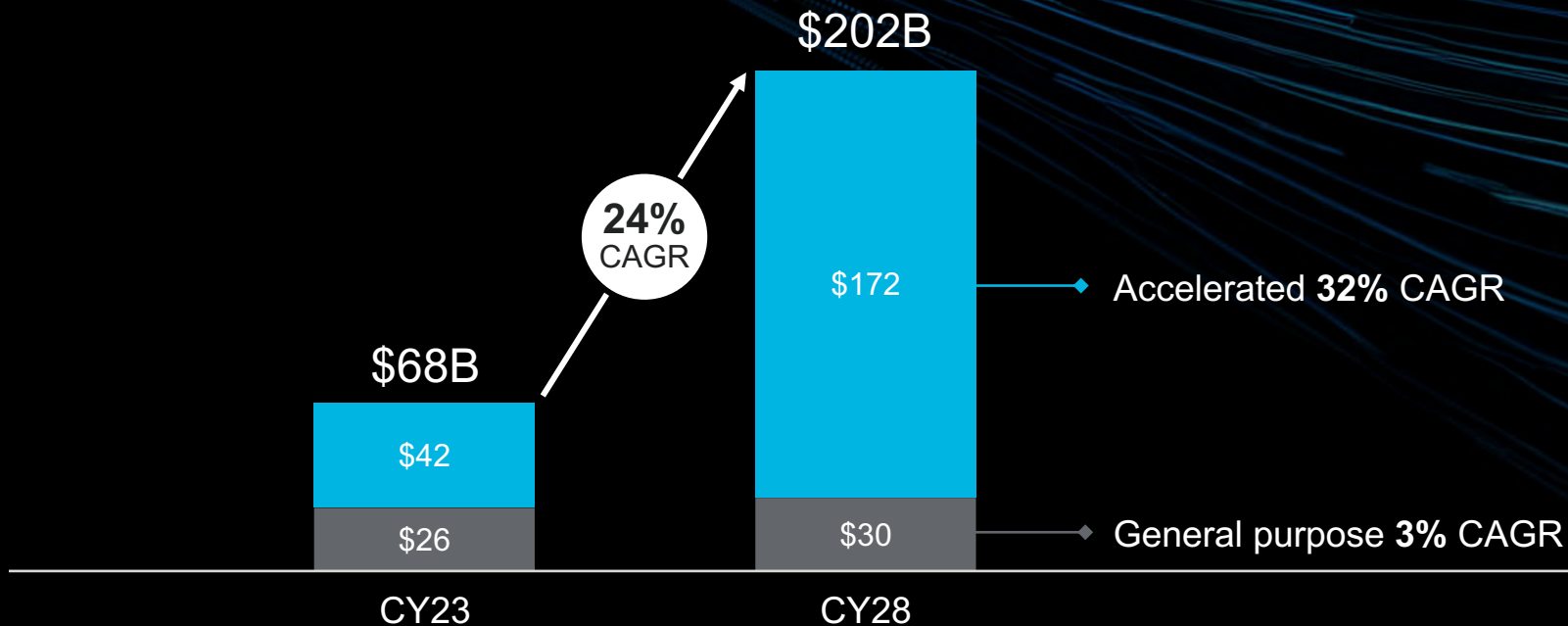

Source: 650 Group, CignalAI, Dell'Oro, LightCounting, and Marvell estimates

Data center **custom compute** opportunity

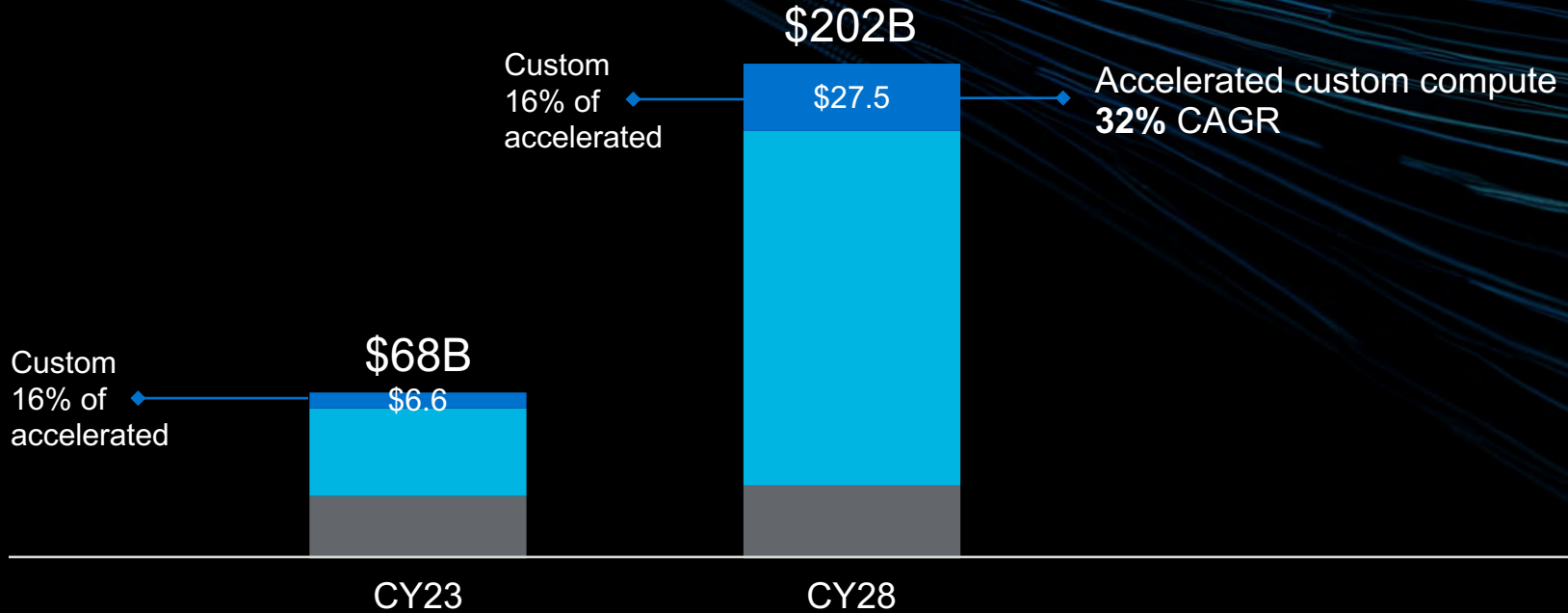

Source: 650 Group, CignalAI, Dell'Oro, LightCounting, and Marvell estimates

Data center **custom compute** opportunity

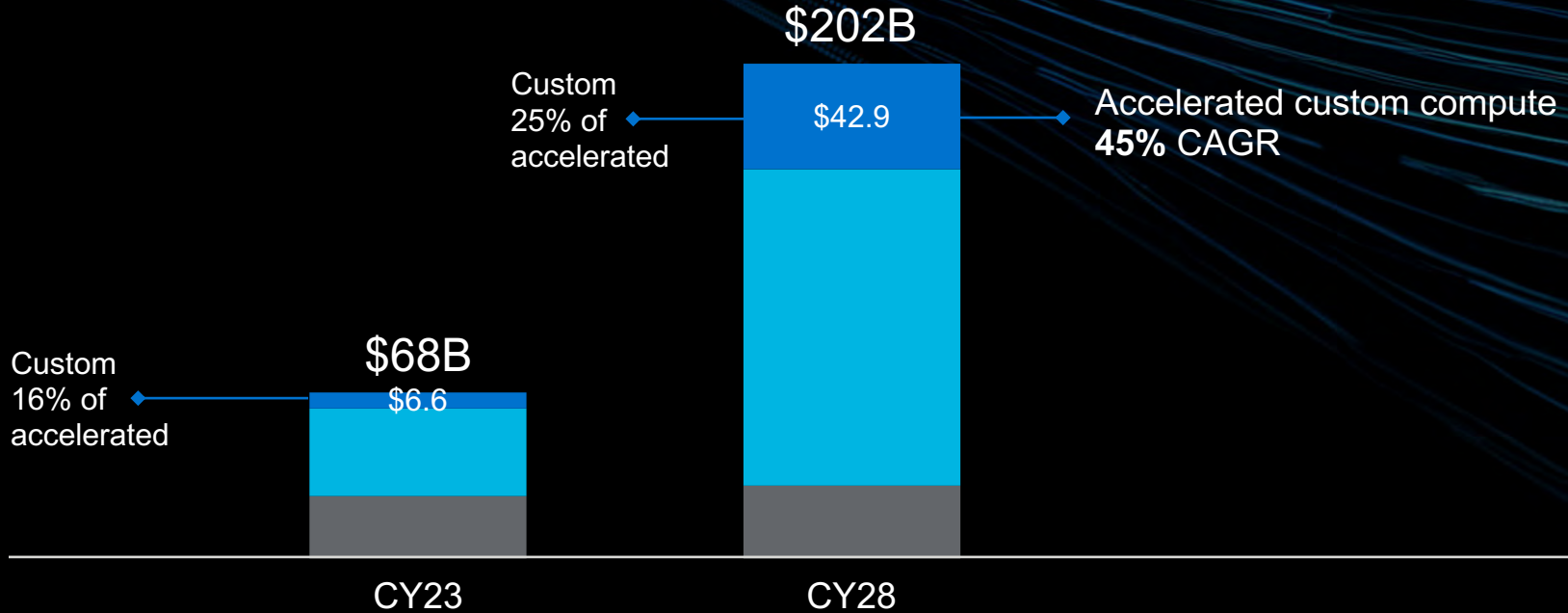

Source: 650 Group, CignalAI, Dell'Oro, LightCounting, and Marvell estimates

Data center **storage** opportunity



Source: 650 Group, CignalAI, Dell'Oro, LightCounting, and Marvell estimates

Data center **interconnect** opportunity



Source: 650 Group, CignalAI, Dell'Oro, LightCounting, and Marvell estimates

Data center **switching** opportunity

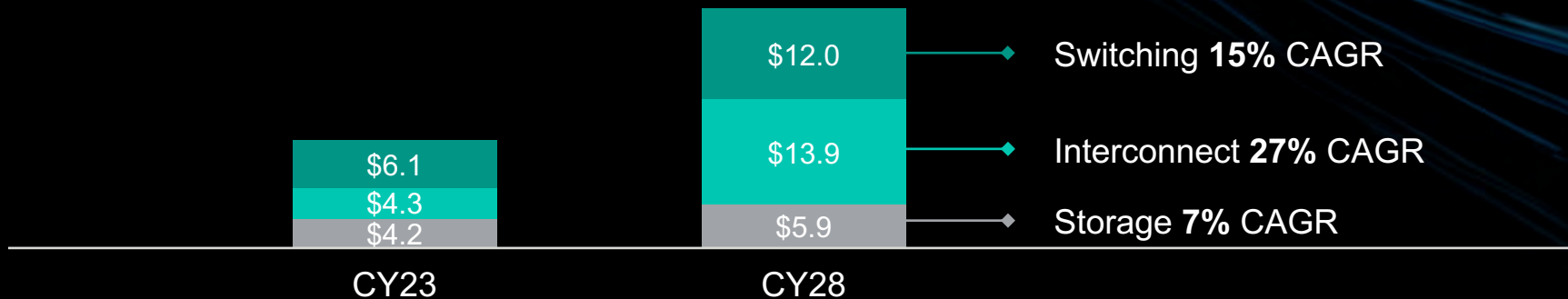

Source: 650 Group, CignalAI, Dell'Oro, LightCounting, and Marvell estimates

Marvell data center TAM

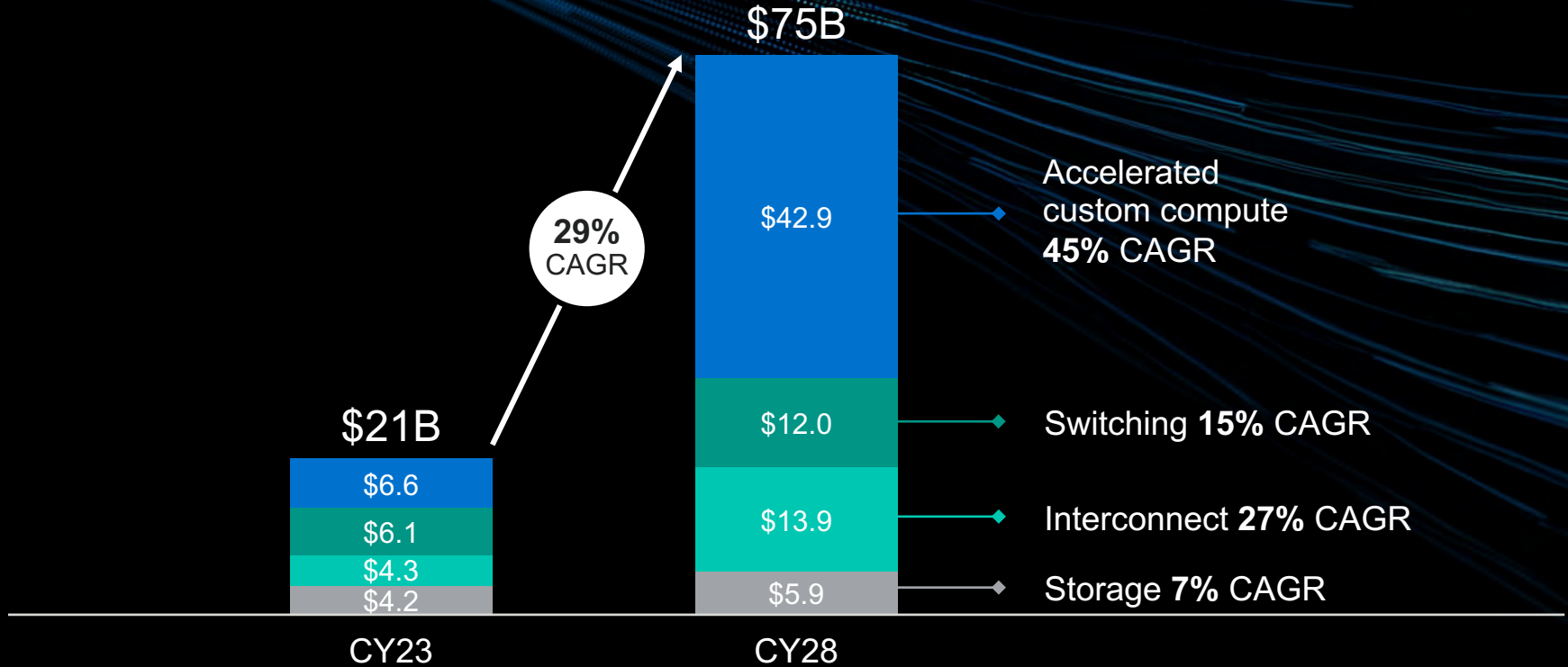

Source: 650 Group, CignalAI, Dell'Oro, LightCounting, and Marvell estimates

Fast growing market, expanding share

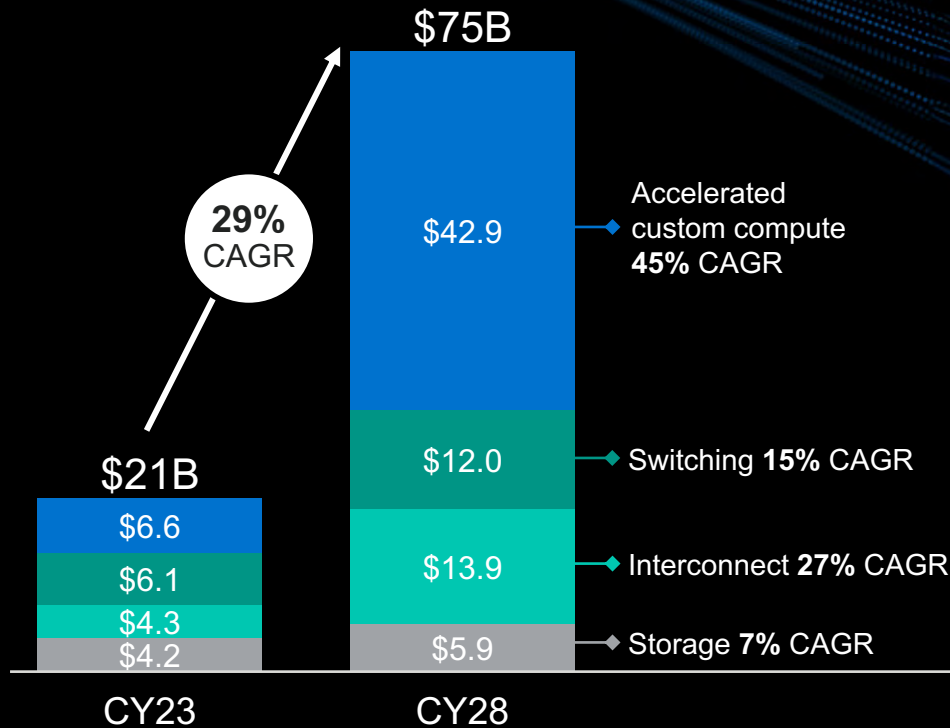

Last year: ~10% share	
End-market	Share expectations
Accelerated custom compute	Gain
Switching	Gain
Interconnect	Maintain
Storage	Maintain

Long-term target: 20% share

Source: 650 Group, CignalAI, Dell'Oro, LightCounting, and Marvell estimates



Loi Nguyen

EVP and GM, Cloud Optics



Interconnects

a key enabling technology
since the dawn of computing

A new beginning

2023 = Year 0

AI

40G

100G

200G

400G

800G

1.6T

3.2T and beyond

2X every 4 years

2X every 2 years

AI doubles interconnect speed in half the time

Optical interconnects enable large AI clusters

128
interconnects

128
XPU

2K
interconnects

1K
XPU

75K
interconnects

25K
XPU

500K
interconnects

100K
XPU

10M
interconnects

1M
XPU

Optical interconnects growing faster than XPU

Training vs Inference – what's the difference?

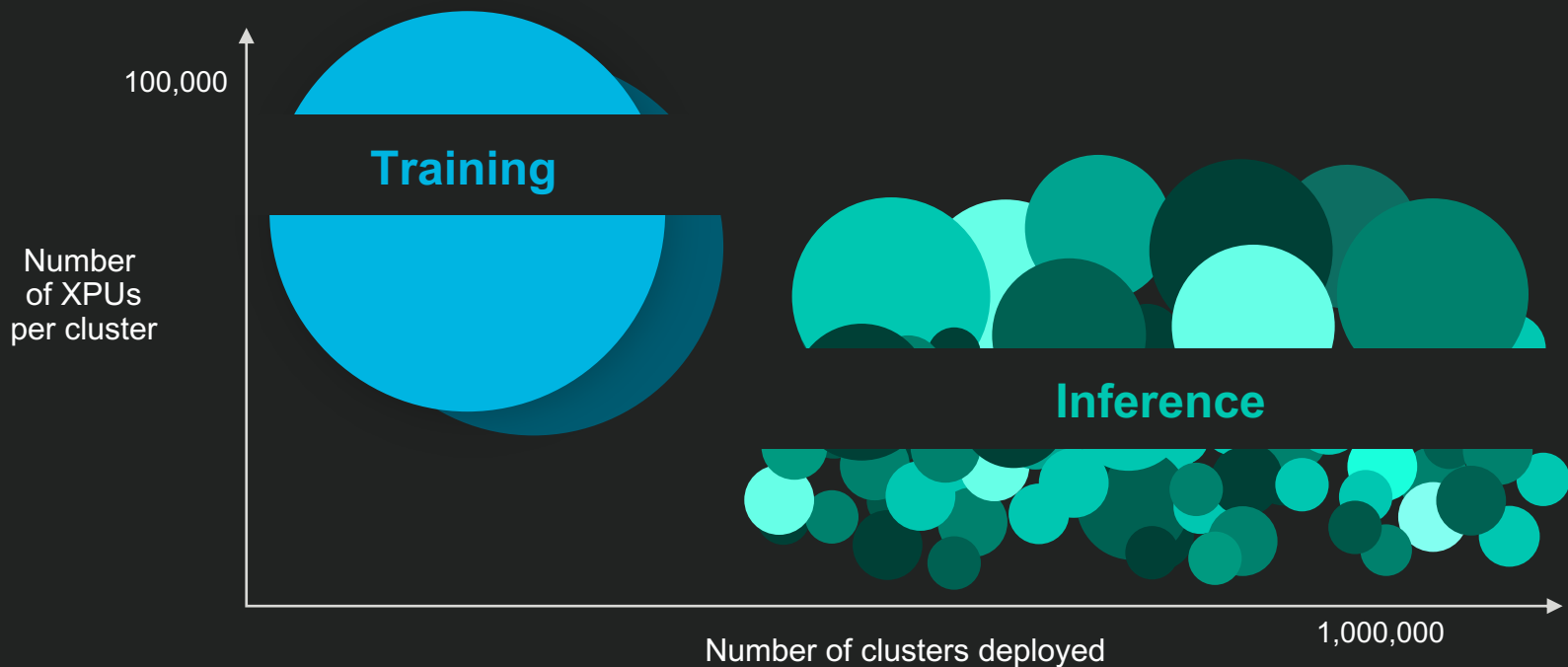

Both drive massive amount of interconnects

Need new infrastructure for AI



- More power
- Better cooling
- Within borders

More data centers, more locations, more interconnects

Source: datacentermap.com

© 2024 Marvell. All rights reserved.

The background features a dark blue to black gradient. It is filled with numerous thin, bright blue lines that appear to be light trails or data paths, curving and radiating across the frame. A prominent feature is a grid of small, white-to-blue dots that forms a perspective grid, receding into the distance. The overall aesthetic is futuristic and technological.

Accelerated Infrastructure

Compute fabric connects XPU's within a server

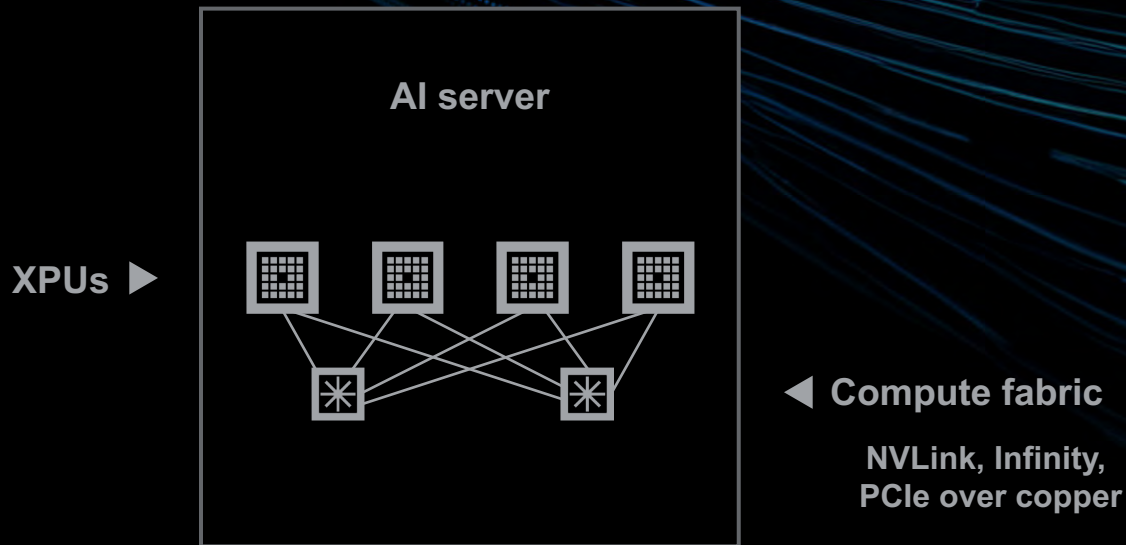

Backend network connects servers within a cluster

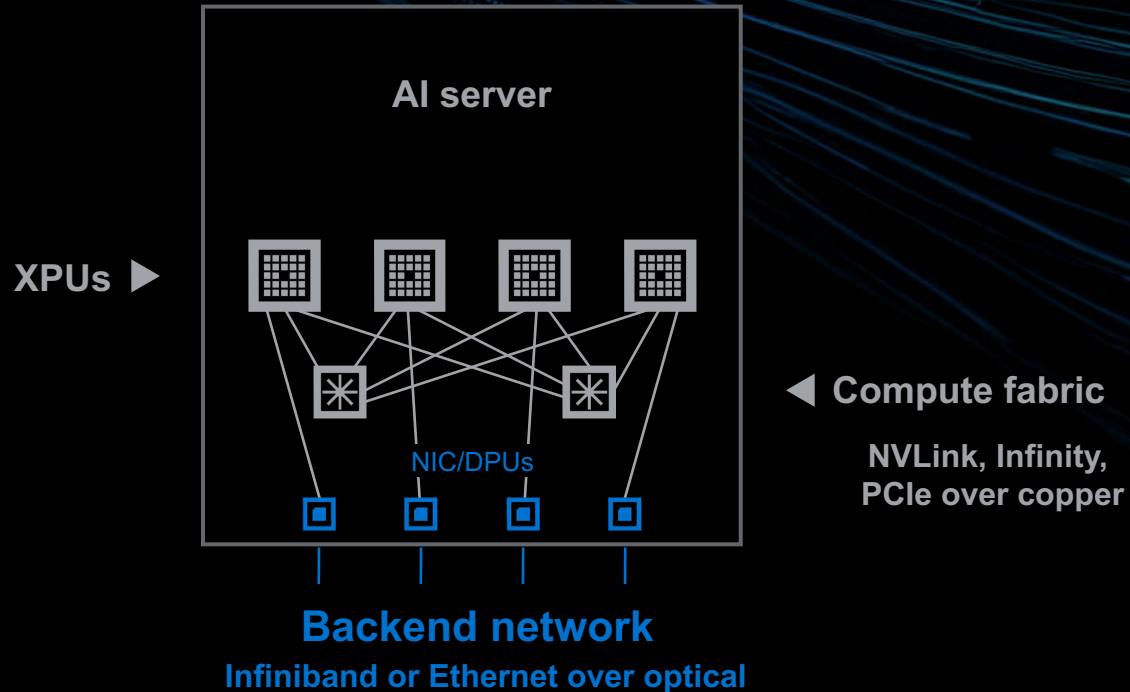

Frontend network connects servers to data center

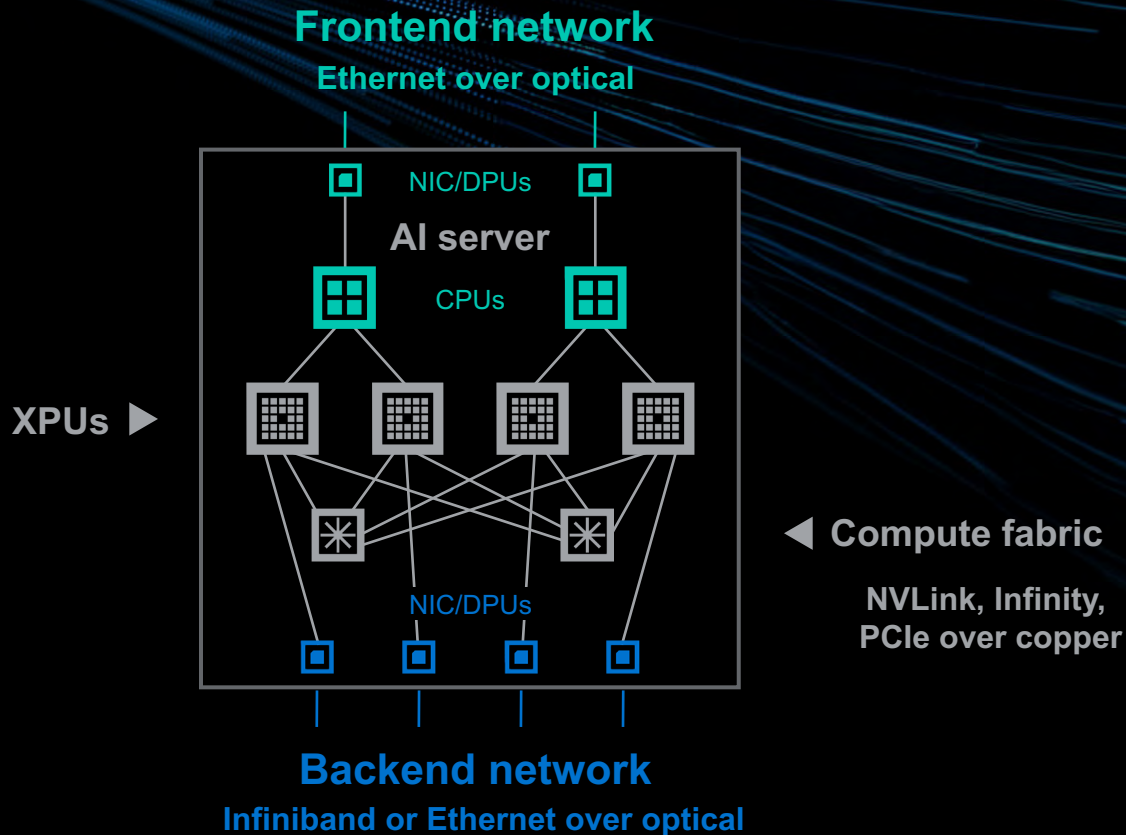

AI cluster with backend network

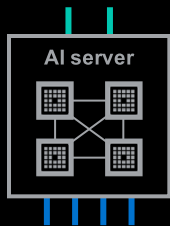

AI cluster with backend network

1000s of servers

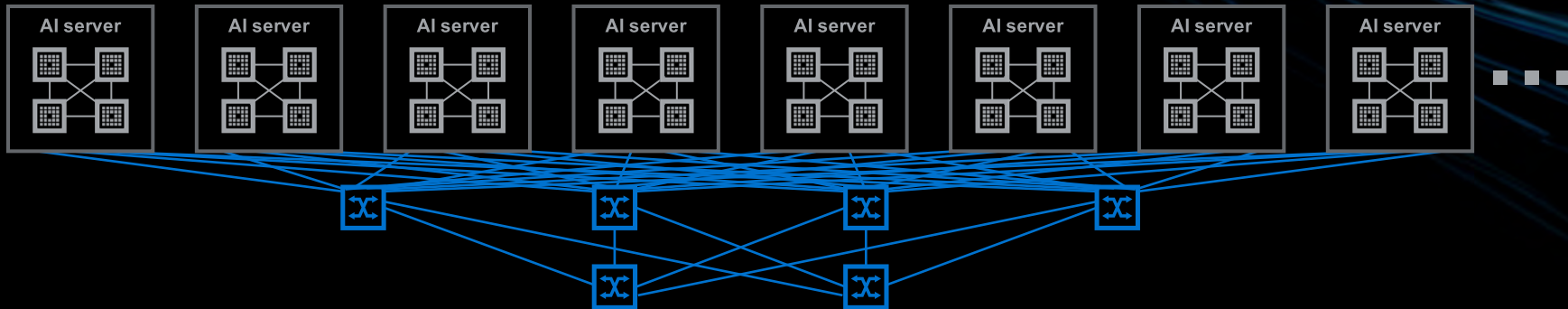

Backend network

AI clusters with backend network

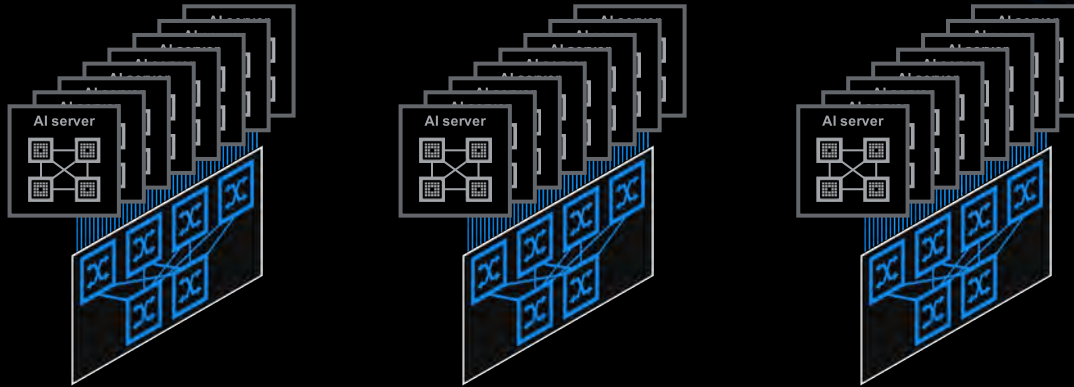

Backend network

AI clusters with backend and frontend networks

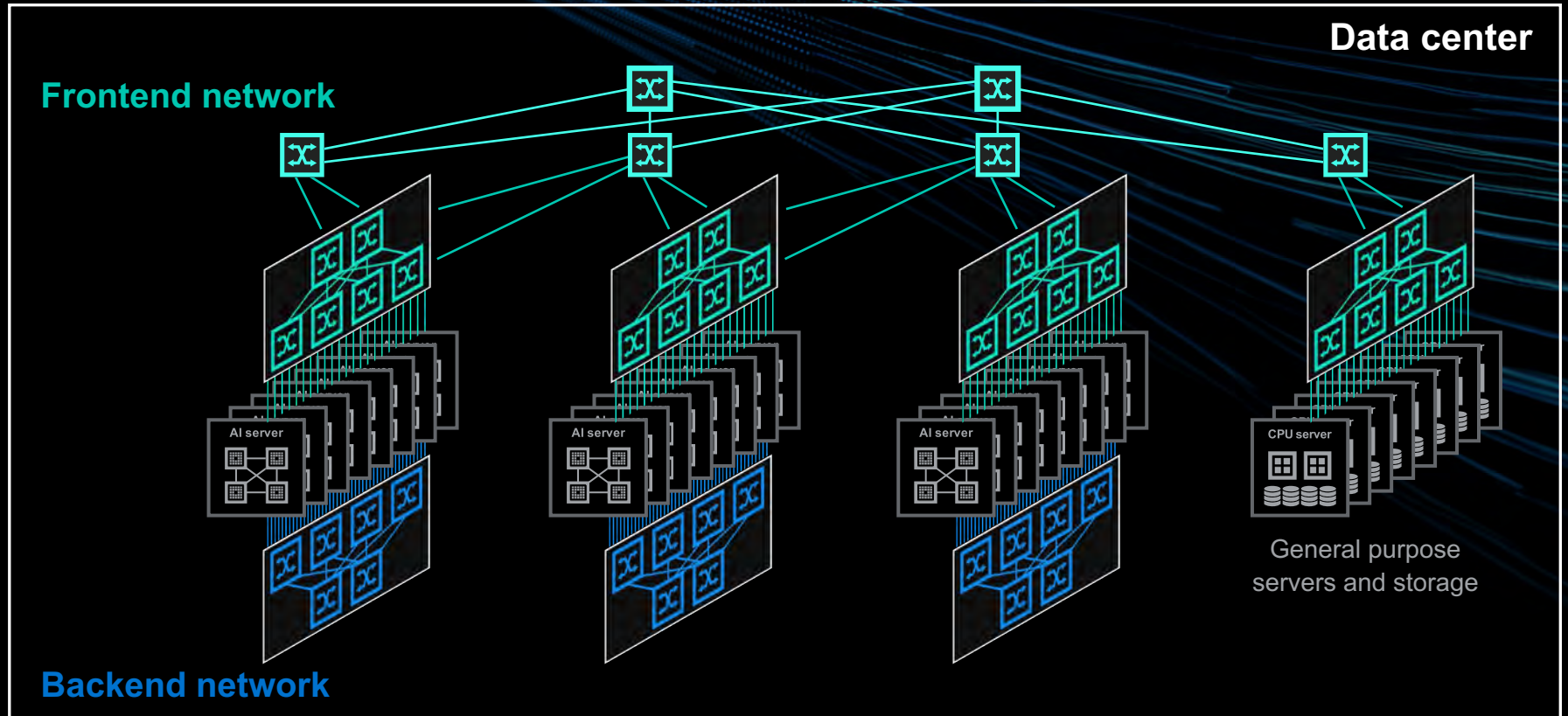

DCI network connects data center to outside world

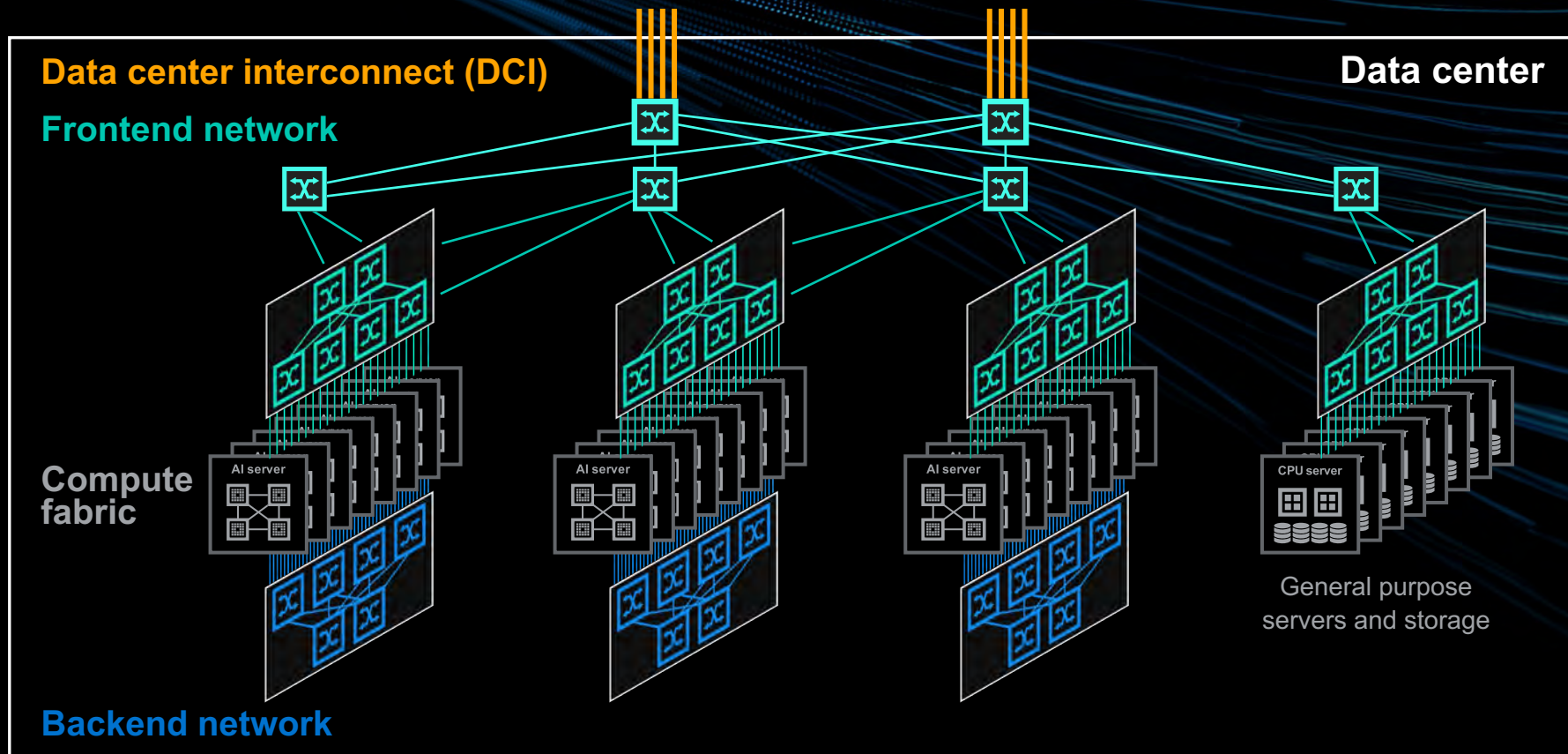

Marvell accelerated infrastructure silicon TAM

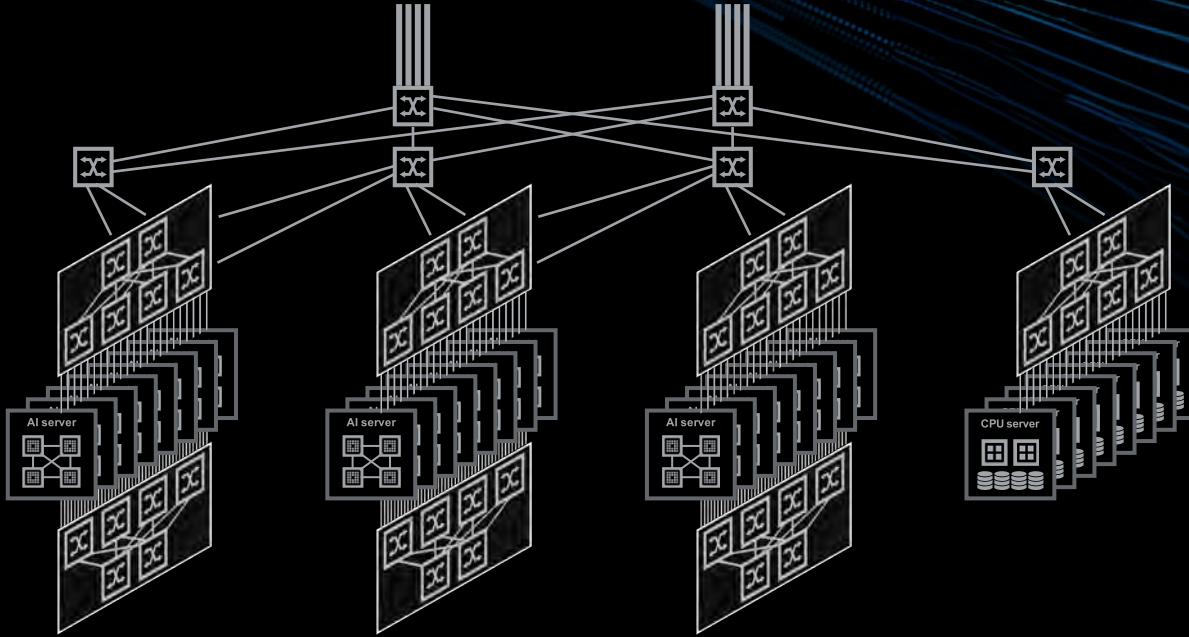

Marvell accelerated infrastructure silicon TAM

Marvell DCI
interconnects

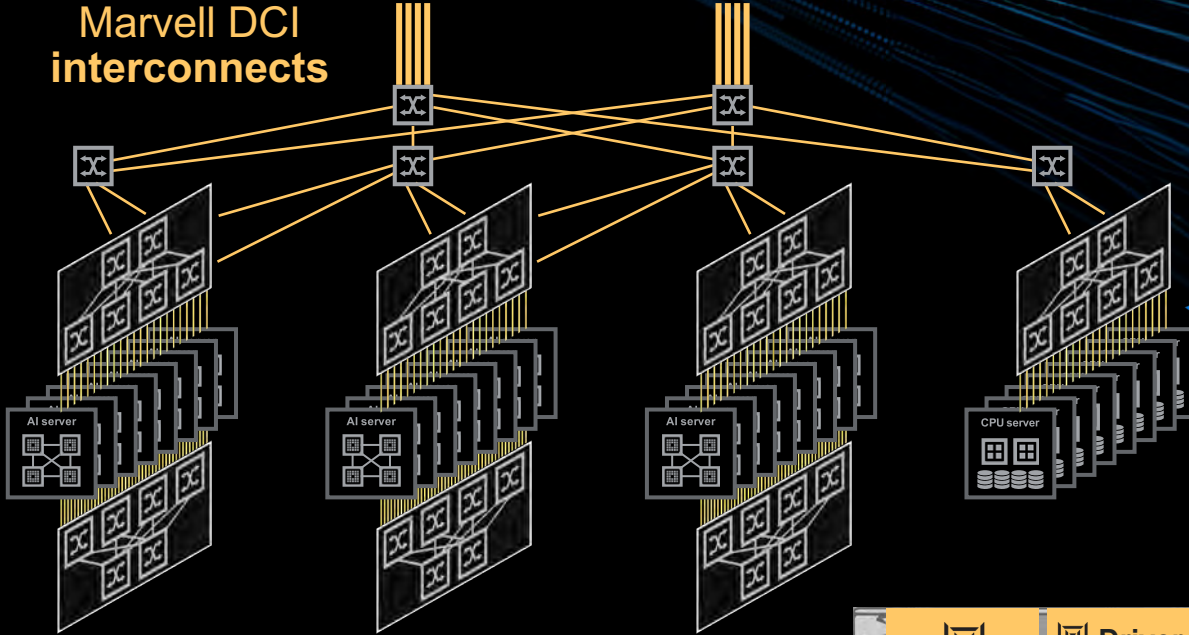

Optical interconnects

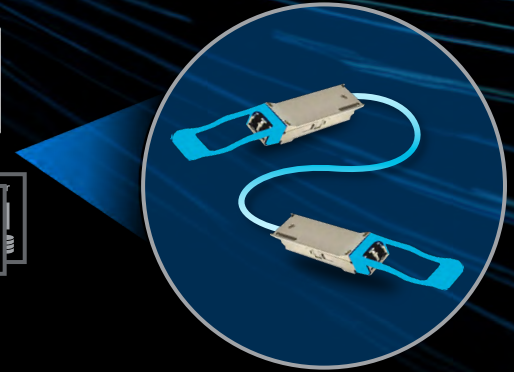

Marvell inside data center
interconnects



Marvell accelerated infrastructure silicon TAM

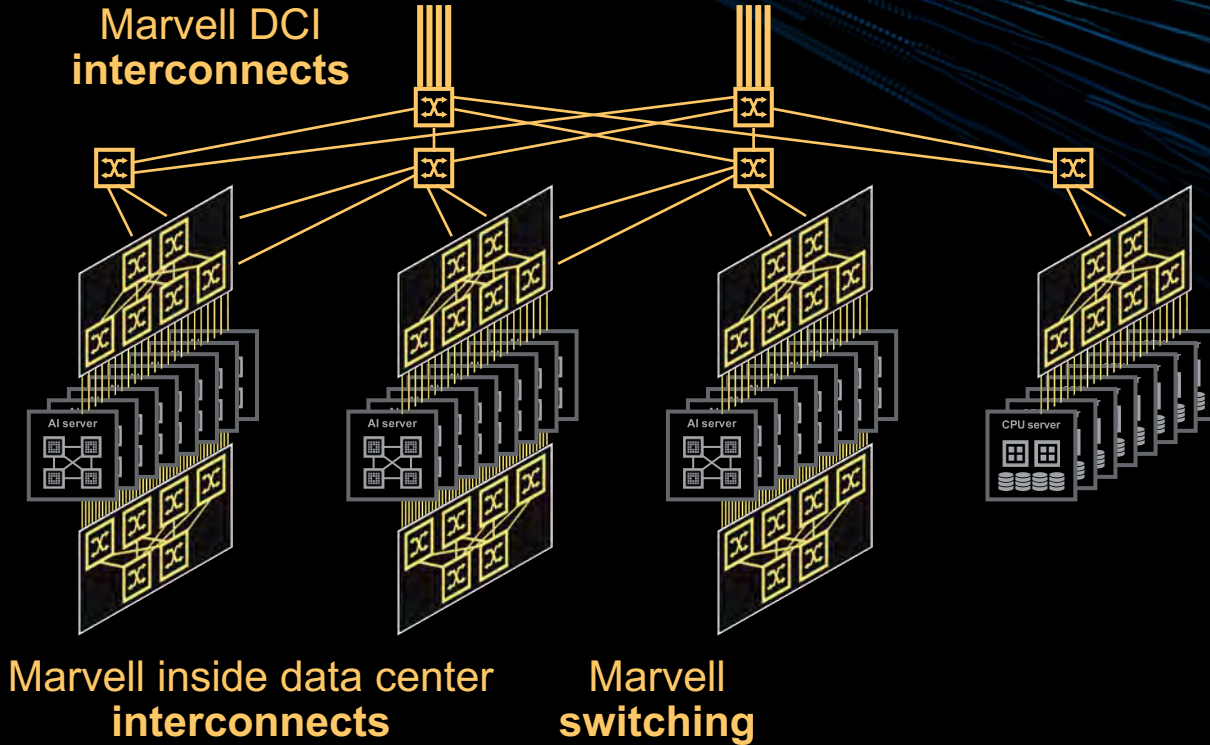

Marvell inside data center
interconnects

Marvell
switching

Marvell accelerated infrastructure silicon TAM

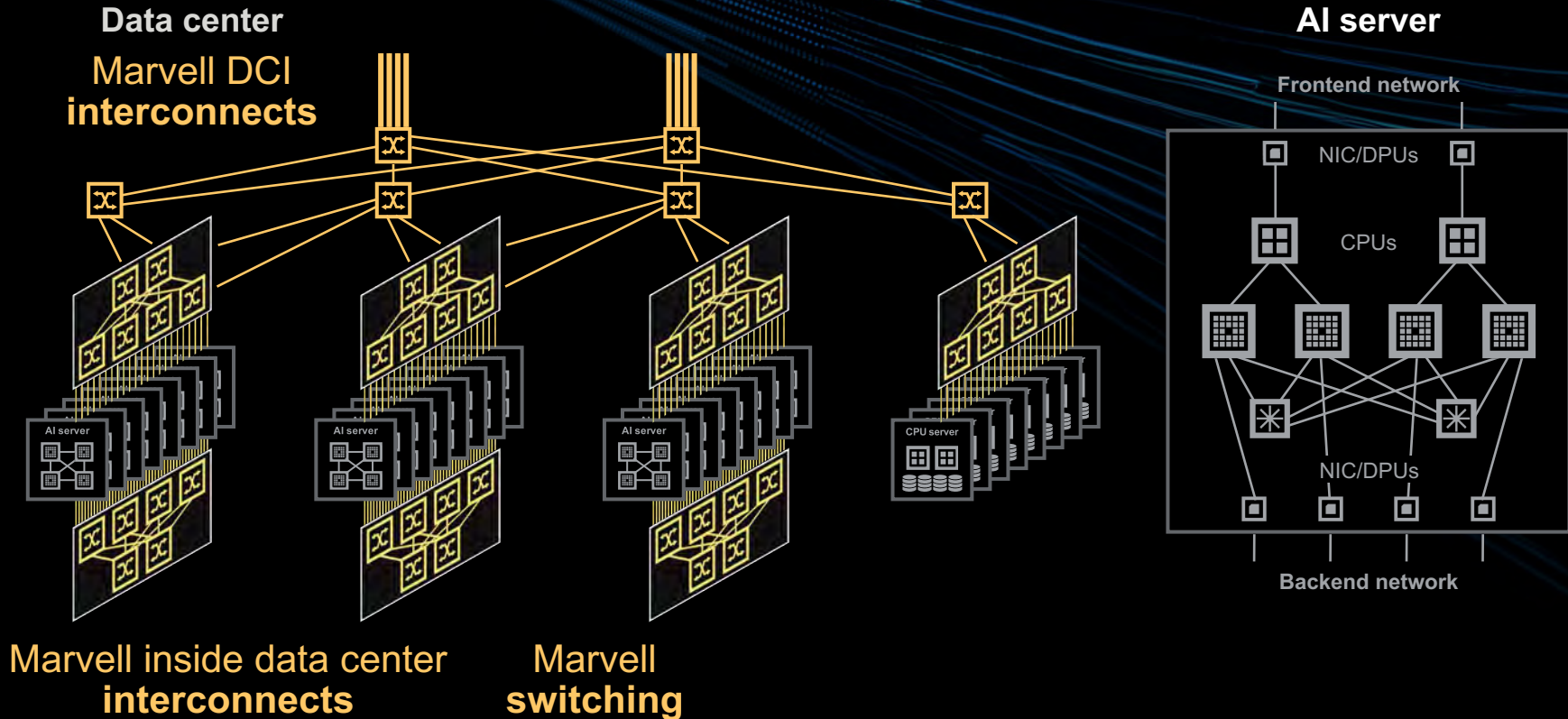

Marvell accelerated infrastructure silicon TAM

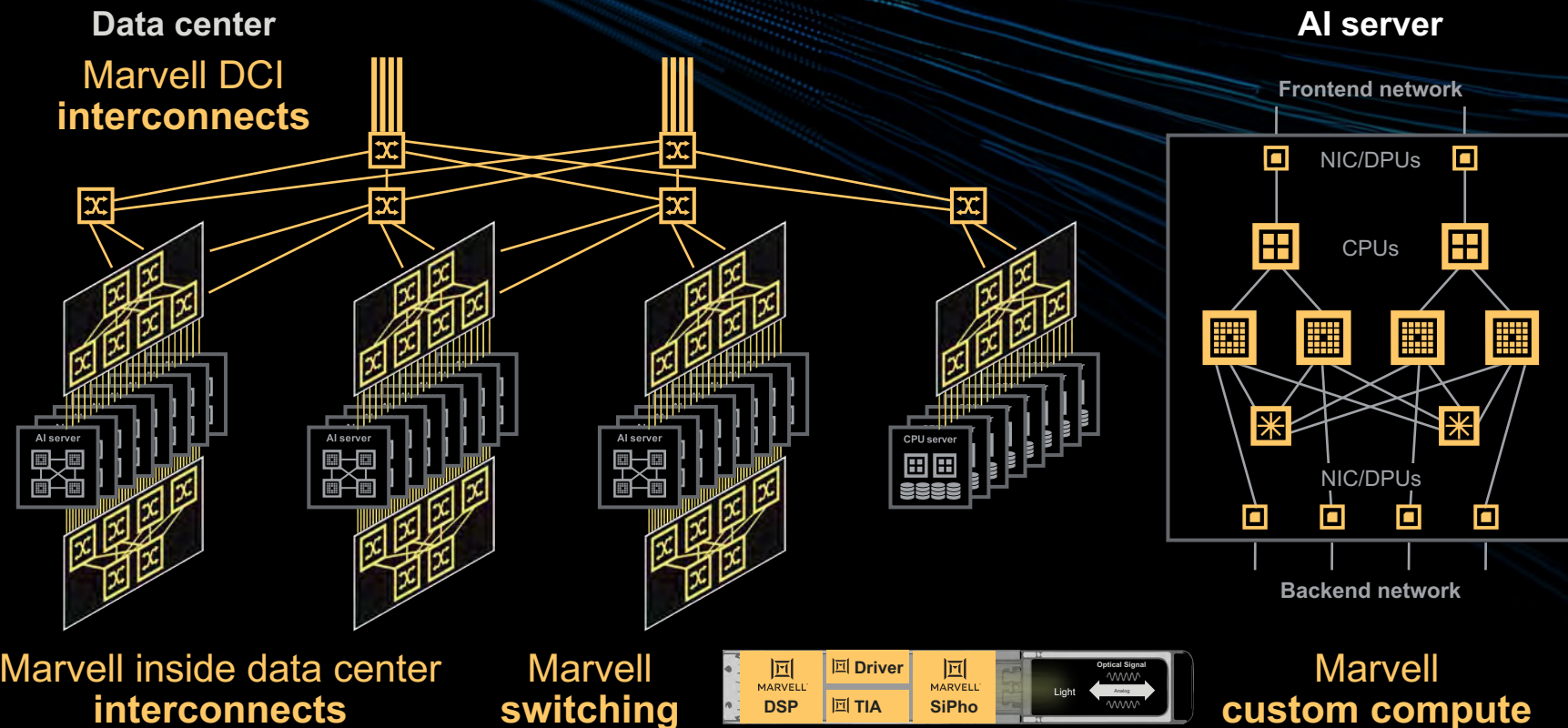



Achyut Shah

SVP and GM, Connectivity

Achyut Shah

SVP and GM, Connectivity

Maxim, VP and GM

Cloud and Data Center BU
1998 – 2020

BSEE, MBA

Michigan Tech University
Santa Clara University

Data center interconnect (DCI)

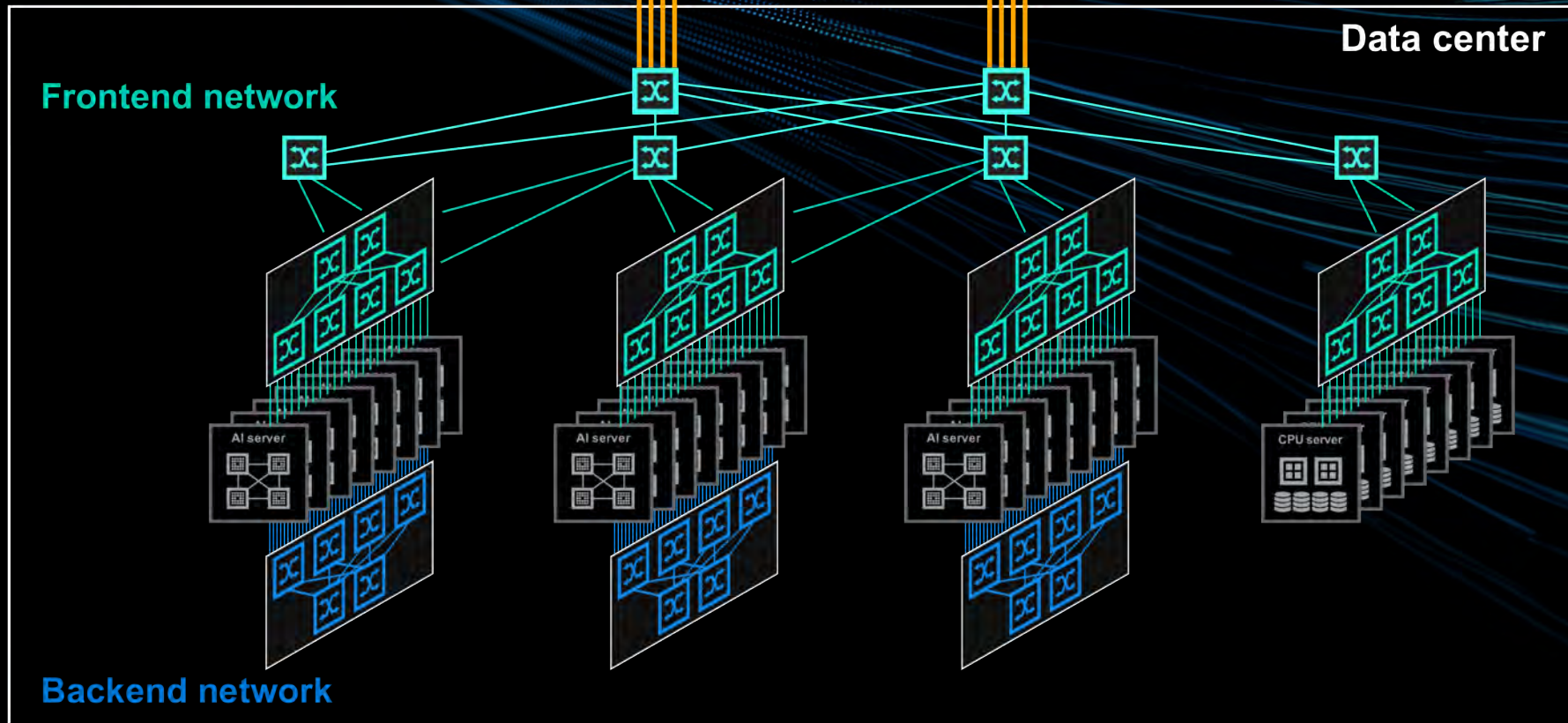

What's inside an **optical** interconnect module?

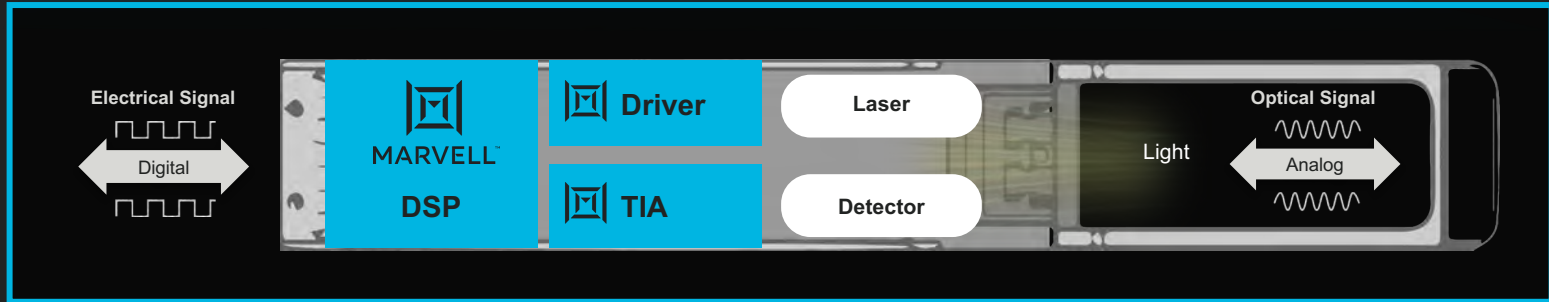
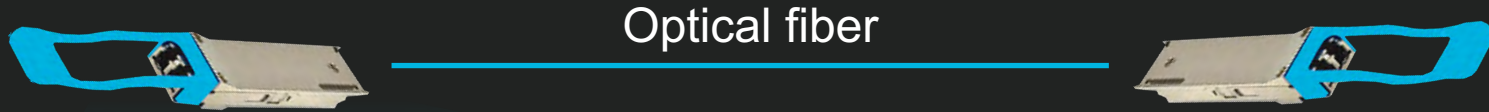

Technology leadership at scale

Leading node digital

- PAM IP
- Coherent IP
- Signal processing
- Forward error correction

High frequency analog

- SiGe TIA
- SiGe driver
- CMOS TIA
- CMOS driver

System level IP

- Diagnostics
- Telemetry
- Firmware
- Software

Deep customer partnerships, complete IP upgrade every 2 years

Inside data centers

Frontend network
Backend network



Multi-generational **leadership** in PAM platform



First PAM DSP

200G

4 x 50G

First 100G
per lane

400G

4 x 100G

Enabled
AI ramp

800G

8 x 100G

First 200G
per lane

1.6T

8 x 200G

AI **accelerates** need for higher speed

Higher speed → Higher content

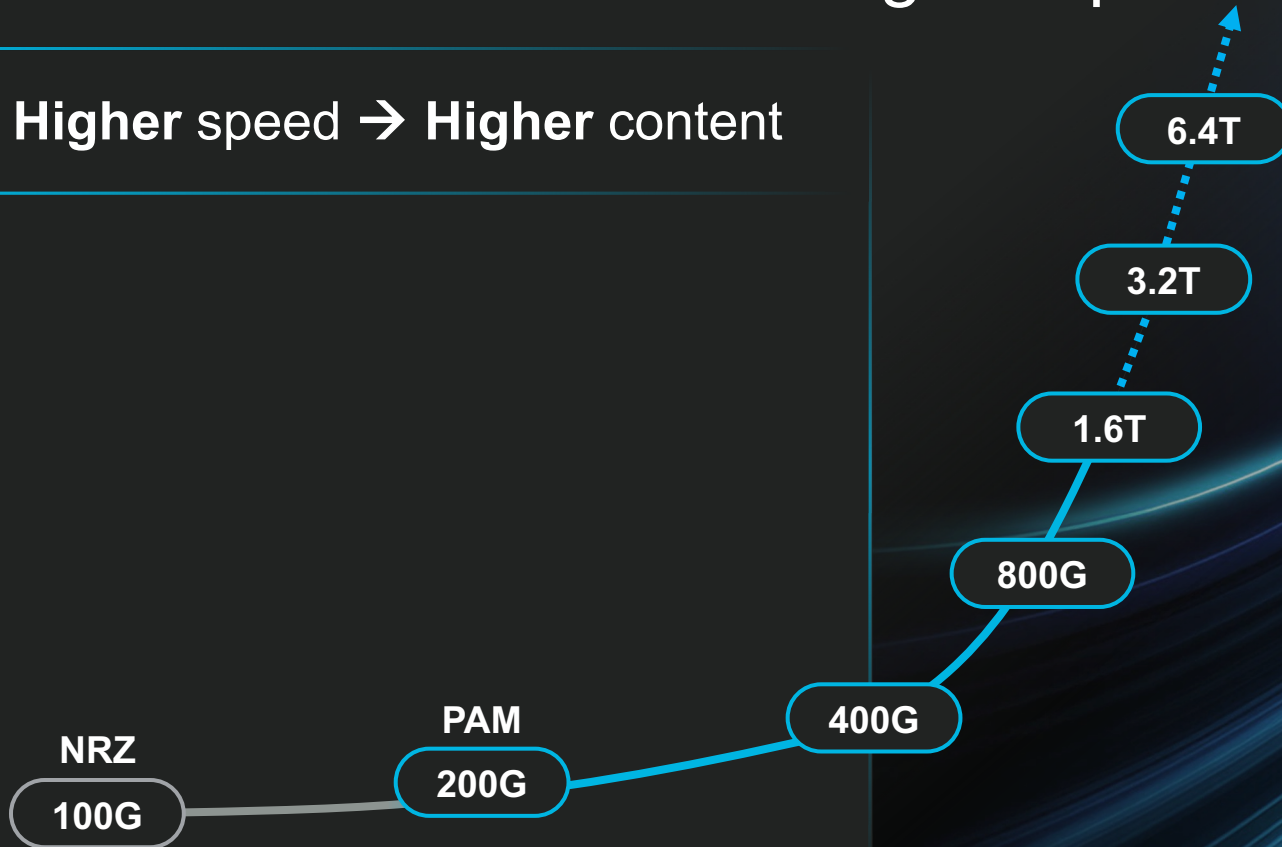

New opportunity

Active Electrical PAM DSPs



Where are copper interconnects used?

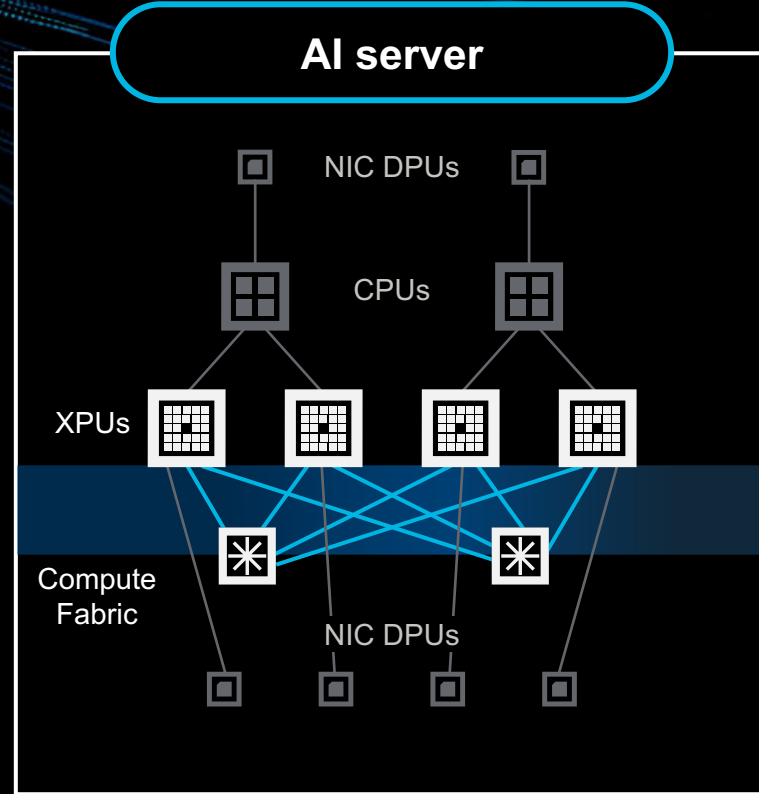
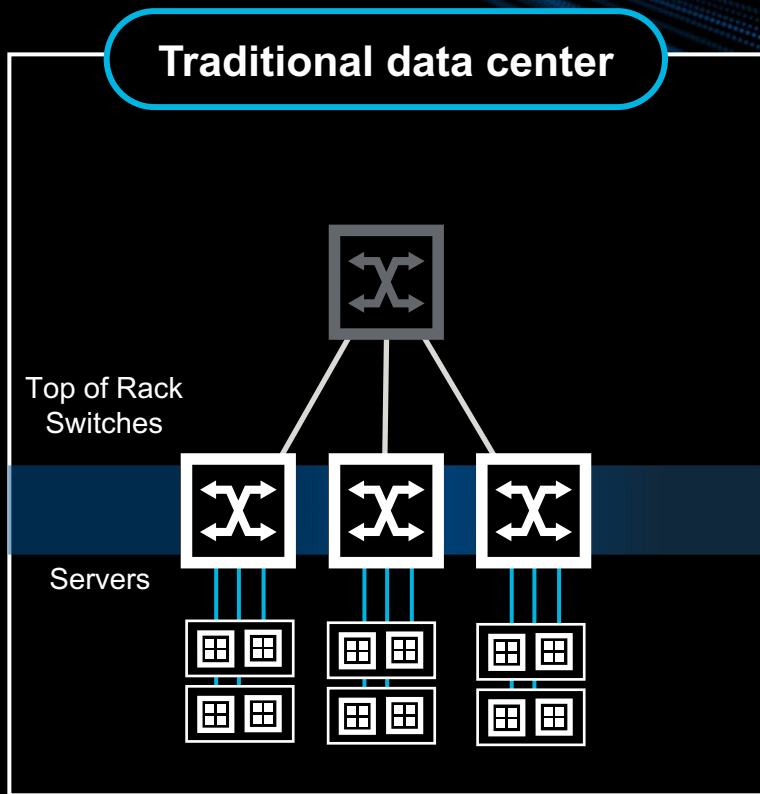

Higher speeds drive need for **active interconnects**

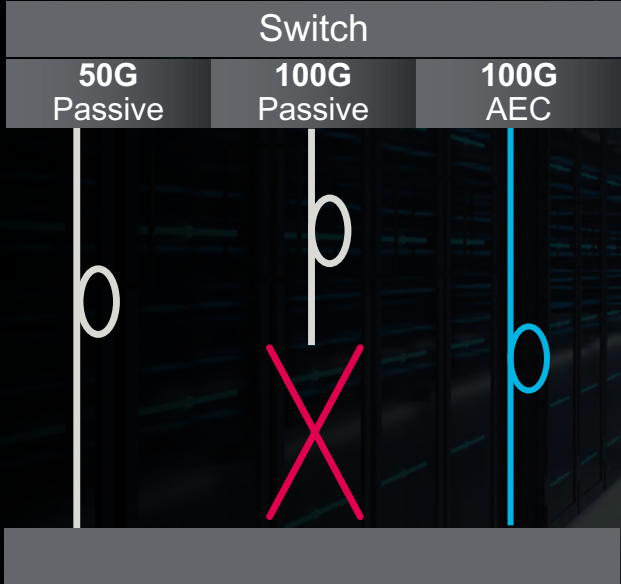

AEC PAM DSPs
Active Electrical Copper



Go to market

Cable partners

Amphenol



molex



3M



BizLink

ZHAOLONG



LUXSHARE ICT



Scalable ecosystem

New
\$1B
DSP TAM



Shipping now to
hyperscale customers

Between data centers

Data center interconnect
(DCI)



Multi-generational **leadership** in DCI platform



COLORZ® 800

First 800G
Coherent pluggable

COLORZ® 400

First **Coherent**
DCI pluggable

COLORZ® 100

First DCI
pluggable

DCI TAM expansion

Current DCI market

120 kilometers
pluggable



Marvell COLORZ® 400 / 800

Market
opportunity
doubling

New DCI opportunity

1,000 kilometers

Transport box



transition to **pluggable**

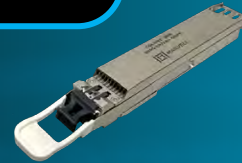

Marvell COLORZ® 800 with PCS
probabilistic constellation shaping

New
\$1B
DCI TAM

Larger AI clusters require **new interconnect**

Inside data center

<2 kilometers

1.6T PAM

Larger data centers or campus

2-20 kilometers

1.6T inside data center coherent

NEW!

Marvell inside data center coherent sampling 2H CY24

Complete interconnect portfolio



Highest speed PAM4 DSPs



Drivers, TIAs



SiPho



Highest speed coherent DSPs



AEC DSP



Integrated DSPs



Inside data center coherent



COLORZ® DCI modules

200G to 1.6T and beyond, 1 meter to 1,000 kilometers

Marvell interconnect TAM

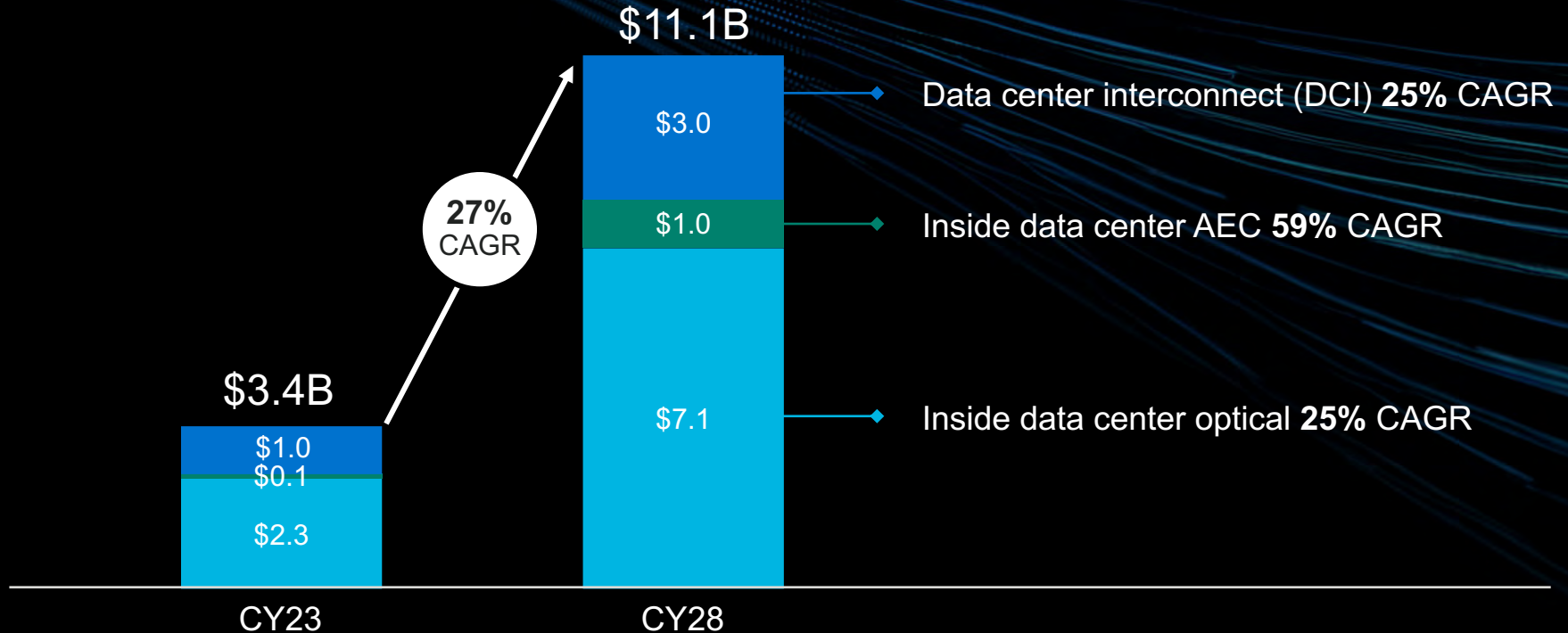

Source: 650 Group, CignalAI, Dell'Oro, LightCounting, and Marvell estimates



Loi Nguyen

EVP and GM, Cloud Optics

What's inside an **optical** module?

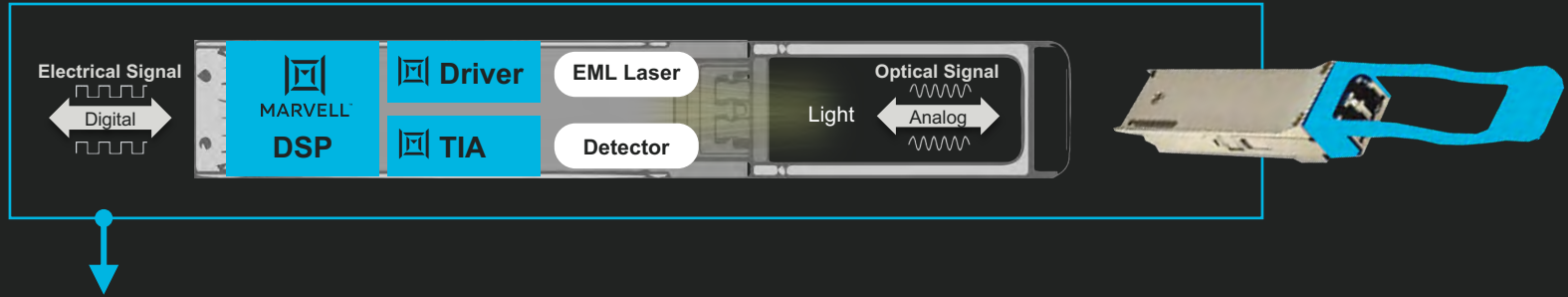

DSP

SerDes, error correction, telemetry, gearbox, interoperability

Driver

Amplifies electrical signal from DSP to drive laser

TIA

(Transimpedance amplifier) Amplifies electrical signal from detector

EML Laser (Electron-absorption modulator laser) High-speed laser

Detector High-speed photo detector

What's inside **silicon photonics** module?



DSP

SerDes, error correction, telemetry, gearbox, interoperability

Driver

Amplifies electrical signal from DSP to drive laser

TIA

(Transimpedance amplifier) Amplifies electrical signal from detector

SiPho

(Silicon Photonics) converts electrical signal to light and vice versa

CW Laser

Continuous wave (CW) laser source

Marvell **SiPho** products shipping in volume



COLORZ® 800

First 800G
Coherent pluggable

COLORZ® 400

First **Coherent**
DCI pluggable

COLORZ® 100

First DCI
pluggable

Scaling of optical interconnects for inside data center

Discrete vs SiPho (1.6T pluggable)

Discrete

Components

8X

High-speed lasers, detectors

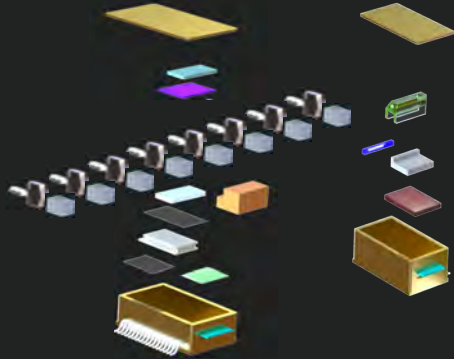

1X

DSP



SiPho

Silicon photonics + CW laser

2X

CW lasers



1X

SiPho



1X

DSP

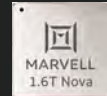

Marvell 3D SiPho engine

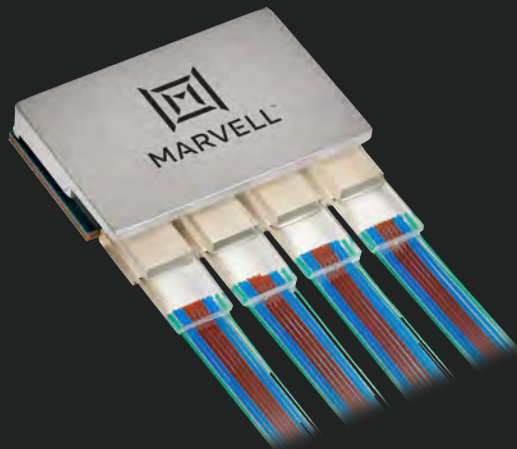

NEW!

32 x 200G electrical and optical

100s components on chip

Modulators, photodetectors, couplers,
MUX, DEMUX, capacitors, resistors

3D integration TIAs and drivers

Scalable 1.6T to 6.4T and more

4X bandwidth, lower cost per bit vs discrete

Marvell 3D SiPho engine

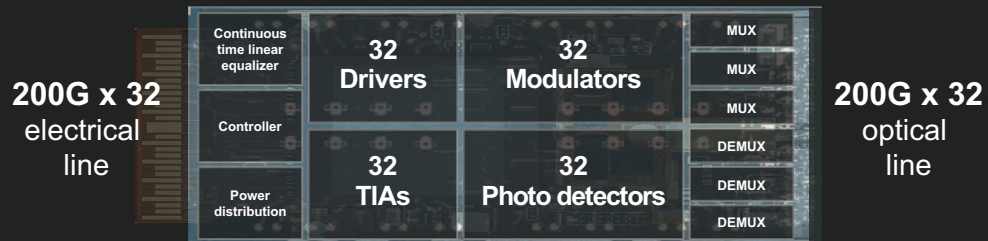

Key terms

Modulator: converts electrical to light

Photo detector: converts light to electrical

Couplers: couples light waves

Multiplexer (MUX): combines wavelengths

Demultiplexer (DEMUX): separates wavelengths

NEW!

32 x 200G electrical and optical

100s components on chip

Modulators, photodetectors, couplers,
MUX, DEMUX, capacitors, resistors

3D integration TIAs and drivers

Scalable 1.6T to 6.4T and more

4X bandwidth, lower cost per bit vs discrete

3D SiPho engine multiple use cases



Inside pluggable
Next year

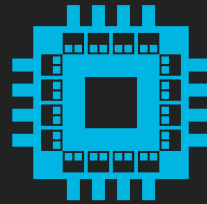

Co-packaged optics
Future

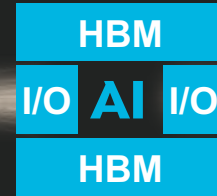

Optical chiplets
Future

Building blocks for scaling of optics

Marvell interconnect TAM

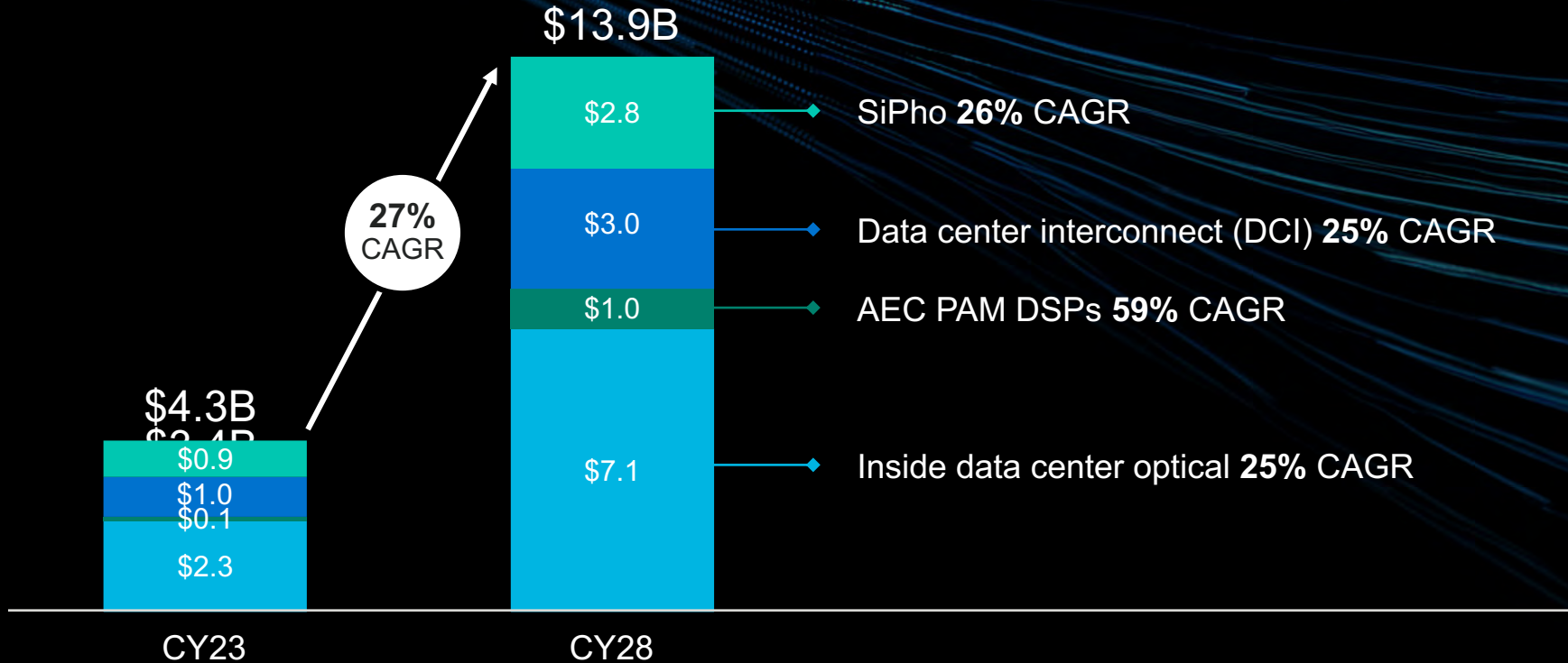

Source: 650 Group, CignalAI, Dell'Oro, LightCounting, and Marvell estimates

A scenic landscape at sunrise. A paved road with a white center line leads from the foreground towards a range of mountains in the distance. The sun is low on the horizon, casting a warm, golden glow over the scene. The sky is a mix of blue and orange. The foreground is filled with green grass and some trees on the left. The mountains in the background are silhouetted against the bright sky.

The **dawn** of silicon photonics

Optical interconnects everywhere



Nick Kucharewski

SVP and GM, Network Switching

Nick Kucharewski

SVP and GM,
Network Switching

Qualcomm, SVP and GM

Wireless Infrastructure and Networking BU
2018 – 2023

Broadcom, VP of Product

Core Switching Group
2005 – 2017

Stanford University

Electrical Engineering
B.S. and M.S.

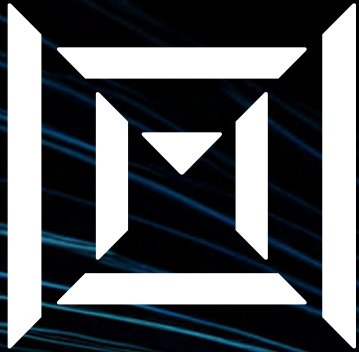

Network Switching

- Market expansion
- Demonstrated capability to deliver
- Opportunities for product innovation
- Essential portfolio technology

Network switching in the data center

Network switching

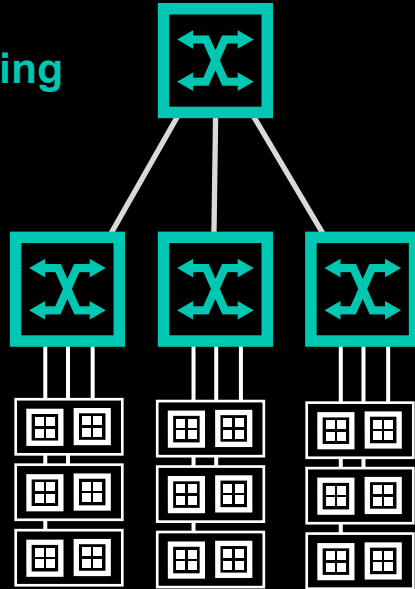

Compute

- Open standards
- Interoperable components
- Scalable to any size

AI calls for enhanced cloud switch architecture

General purpose

One workload,
one processor



Accelerated

One workload,
many connected processors

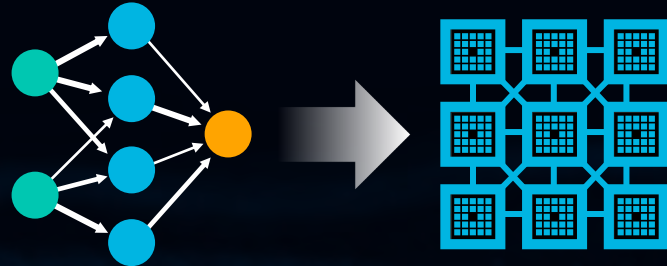

Network performance integral to compute efficiency

Ethernet switching in the AI cloud

Frontend network
Ethernet

Backend network
InfiniBand
Ethernet

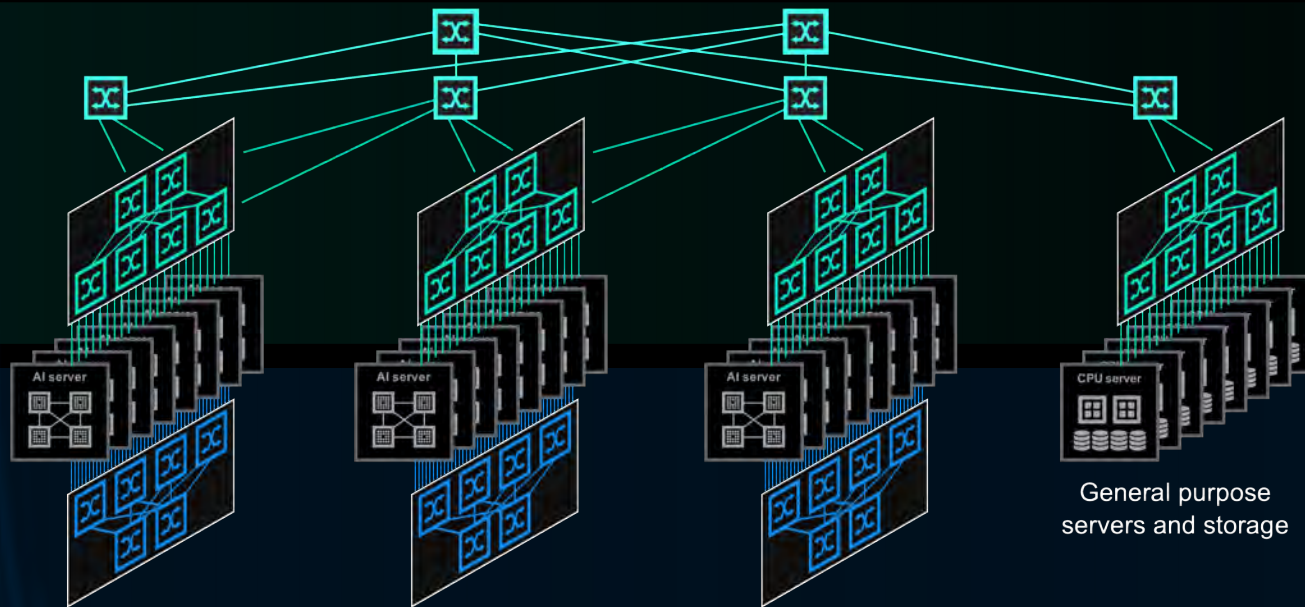

Accelerated compute drives significantly more network ports

Switching is a semiconductor **tour de force**

Single-chip multi-terabit packet switch

with on-chip

- Packet buffer
- Route tables
- Telemetry



Maximum capacity

Advanced process

High-speed serial I/O

Low latency

Power efficient

Marvell cloud switch: a market breakthrough

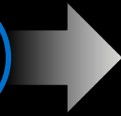

12.8 Tbps

- Clean sheet architecture for cloud
- Delivered at leading speed
- Tier 1 hyperscale design win
- Deployed at high scale

Marvell AI cloud network switch



> 60 billion transistors

- 51.2 Tbps with 100G SerDes
- Marvell 5nm implementation
- Programmable and low latency
- Production summer 2024

New OEM customer design wins

Increased investment in AI cloud switching

Marvell data center switch team

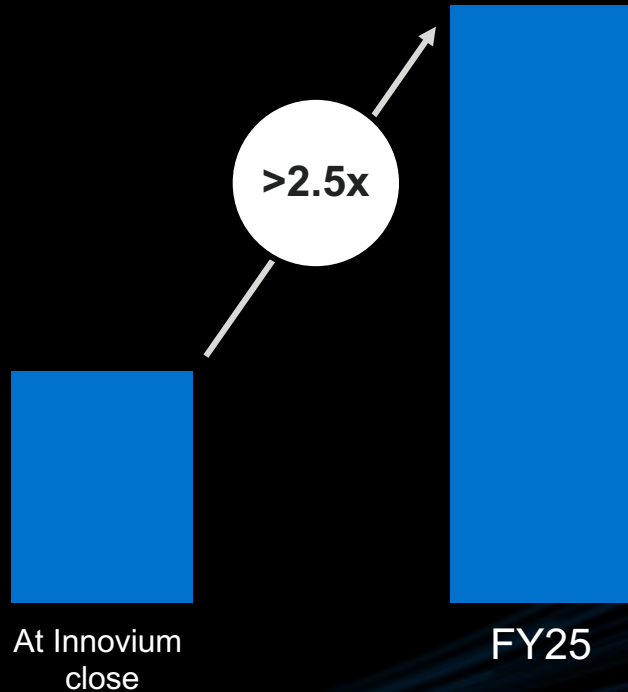

- Consolidated switch organization
- Expanded silicon roadmap
- Increased software and support

Marvell tech portfolio enables switch roadmap

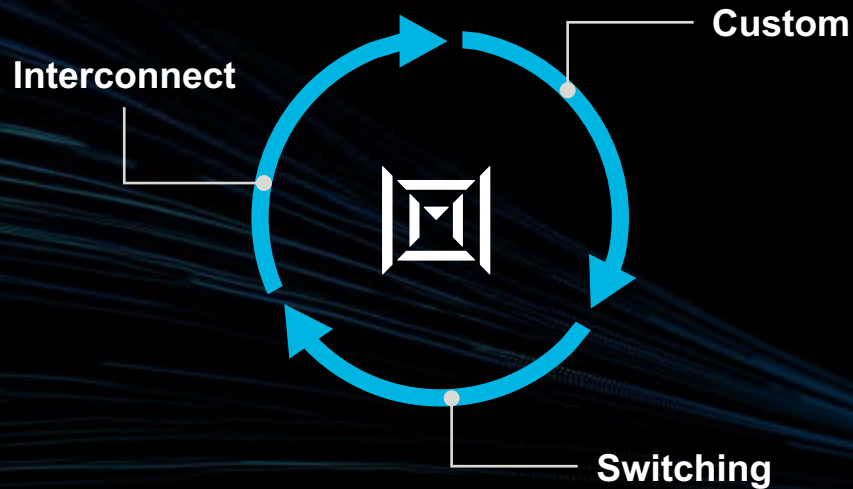

- 3nm and 2nm foundational IP
- 224G SerDes and beyond
- Advanced packaging and assembly
- Silicon photonics

AI motivating cloud switch innovations



Open platforms

Past

Proprietary OS software
Vendor-specific silicon

AI era

Open network OS
Hardware abstraction layer



Workload awareness

Load balancing

Congestion management
Traffic engineering



Network architecture

Build a bigger switch

Blurred boundaries
of switch and interconnect

Novel repartitioning
of large cloud fabrics

Data center switch market

Data center Ethernet switch semiconductor TAM (\$B)

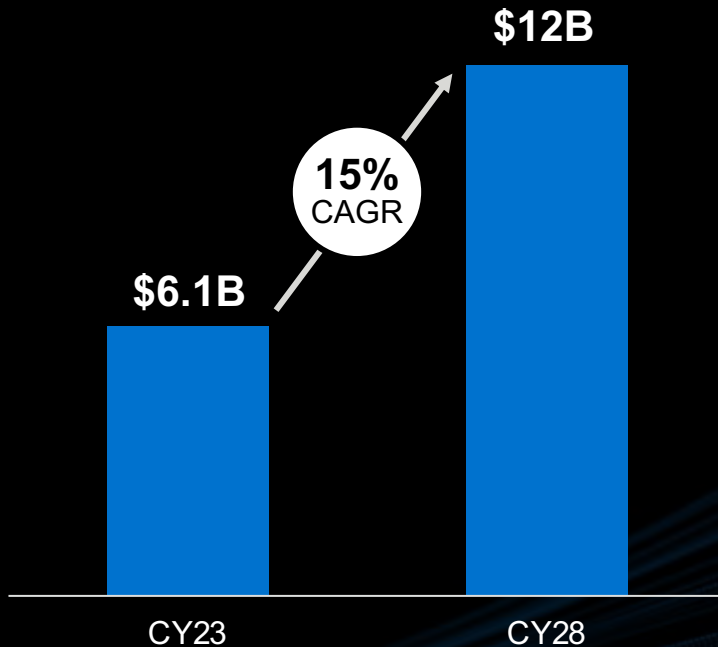

- \$6B TAM across WW data centers
- 15% CAGR
- AI switching growing at faster rate

Source: 650 Group

Marvell switch business accelerating

**Multi-billion \$
opportunity**

**New
customers**

**51.2T production
summer 2024**



Raghiv Hussain

President, Products and Technologies



Industry's first accelerated compute for networking

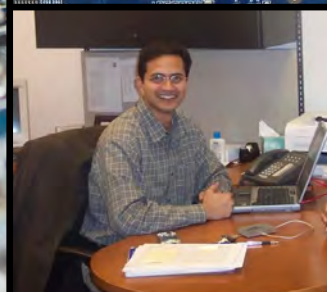

Data center **custom compute** opportunity

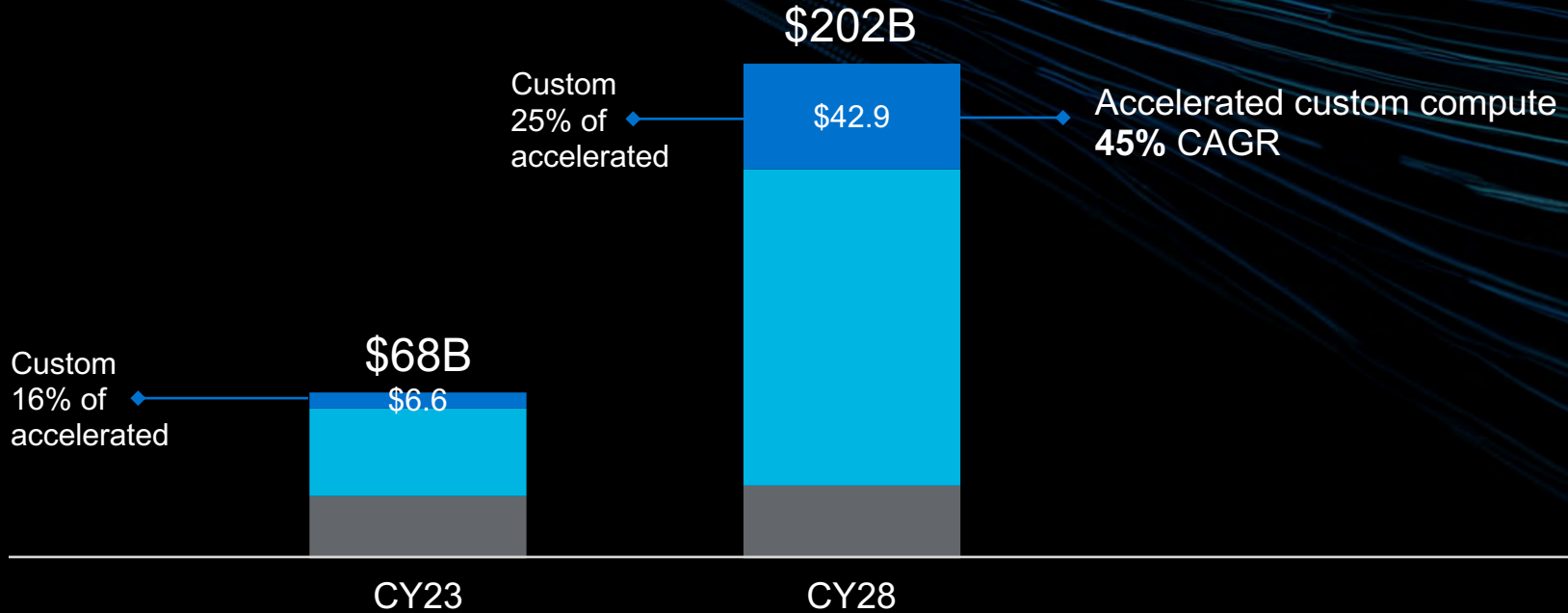

Source: 650 Group, CignalAI, Dell'Oro, LightCounting, and Marvell estimates

Why custom compute?

2021 Investor Day

Every cloud is **unique**

Search

eCommerce

Enterprise applications

IaaS

Social media

© 2021 Marvell. All rights reserved.

MARVELL INVESTOR DAY 2021 12

Multiple business models within cloud

Internal applications

- Google search
- Bing search
- Amazon.com
- Instagram

Software as-a-service (SaaS)

- Microsoft Copilot
- Amazon Bedrock
- Google Vertex AI
- OCI Gen AI
- Snowflake Cortex AI
- OpenAI
- Databricks Mosaic AI

Infrastructure as-a-service (IaaS)

- Azure AI
- Google AI
- AWS EC2 ML
- Oracle AI

Custom silicon adoption



Marvell accelerated infrastructure platform

Process node

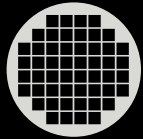

5nm

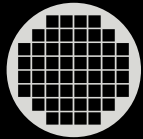

3nm

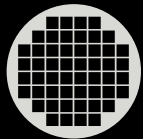

2nm

IP

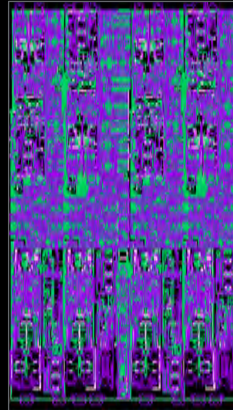

SerDes

Packaging

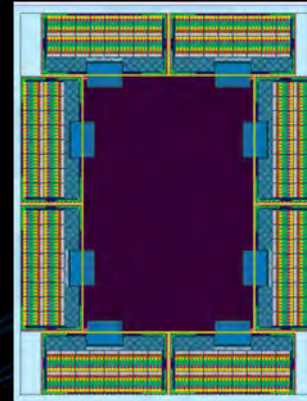

2.5D/3D

Expertise

- Processor
- Large silicon
- Multi-chip
- Chiplet
- High bandwidth
- Networking
- SiPho

Significant R&D scale and IP leadership required

High-performance SerDes

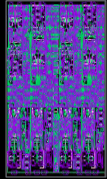

Chip-to-chip (D2D) interconnect

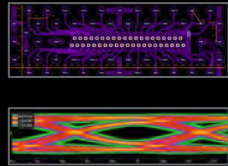

Ultra-high density & low power SRAM

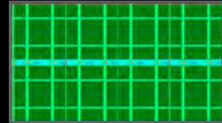

HBM chiplet



In-house tools

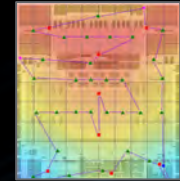

Advanced substrates



2.5D / 3D packaging

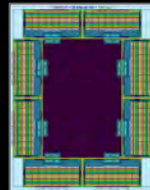

CoWoS-S
CoWoS-R

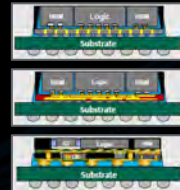

Advanced thermal solutions

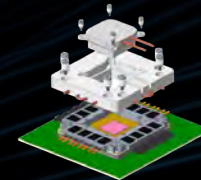

3D SiPho integration

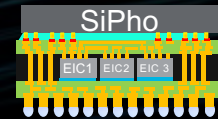

Pushing the boundary of technologies

Expertise and experience

1990

1M transistors

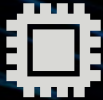

- Functional
- Timing

Now

>100B transistors

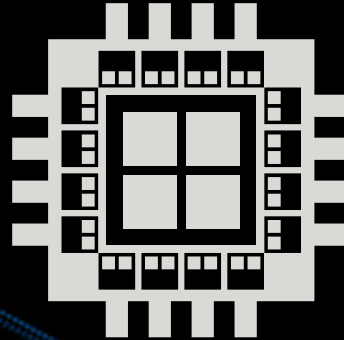

- Functional and timing
- Cross-die timing
- Multi-chip
 - Power
 - Connectivity
 - Thermal
- Signal integrity
- Mechanical stress

Only large infrastructure companies can succeed

Decades of world-class IP



Significant investment in complete custom platform

Multiple custom compute opportunities

Accelerated compute for AI

XPU



CPU



Custom compute

Security



NIC / DPU



Arm compute



Storage



Video



CXL



Multiple custom compute products

Accelerated compute for AI

XPU



CPU



Custom compute

Security

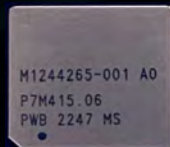

NIC / DPU



Arm compute

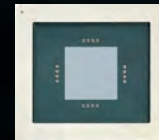

Storage



Video

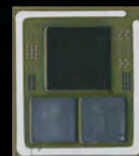

CXL



Two custom compute examples

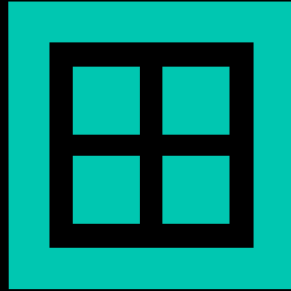

CPU

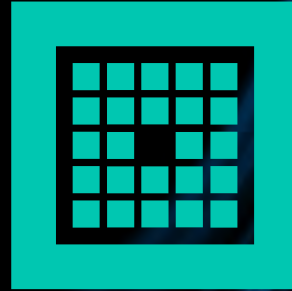

AI accelerator

Putting it all together: CPU custom compute

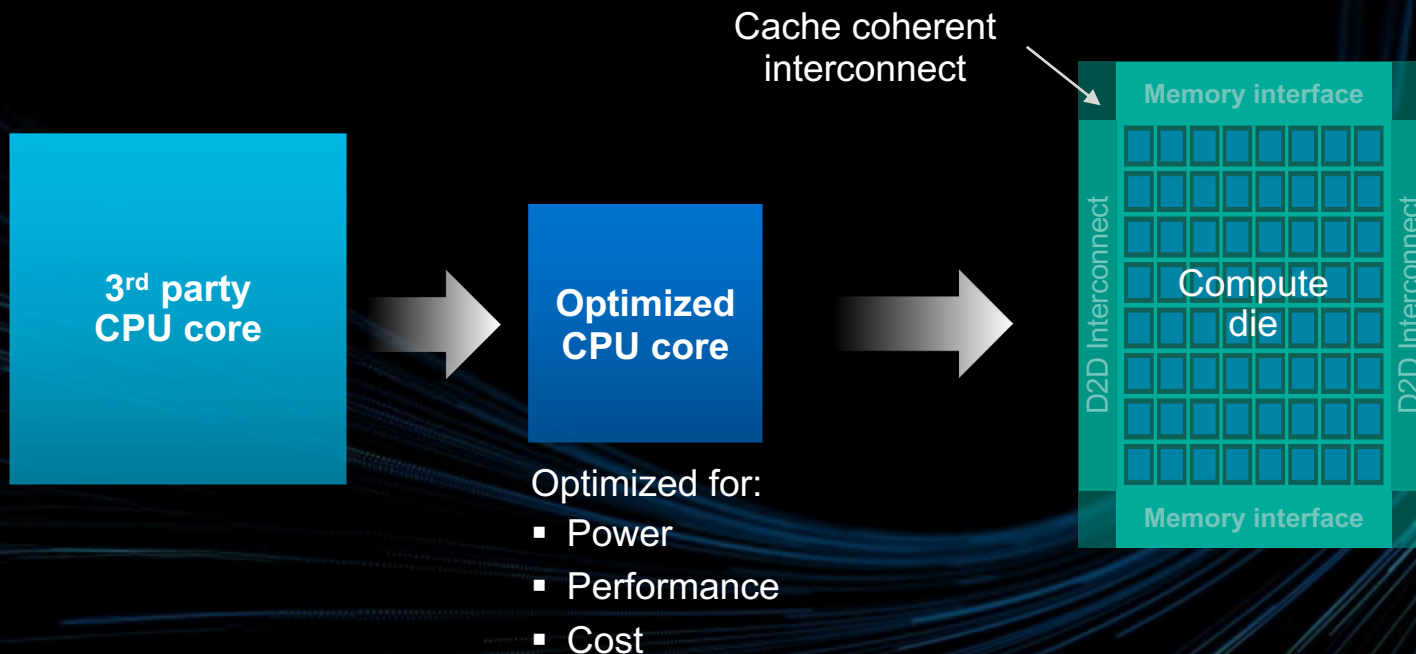

Custom compute CPU

Decades of experience
in building complex
compute SoCs

Advanced
package

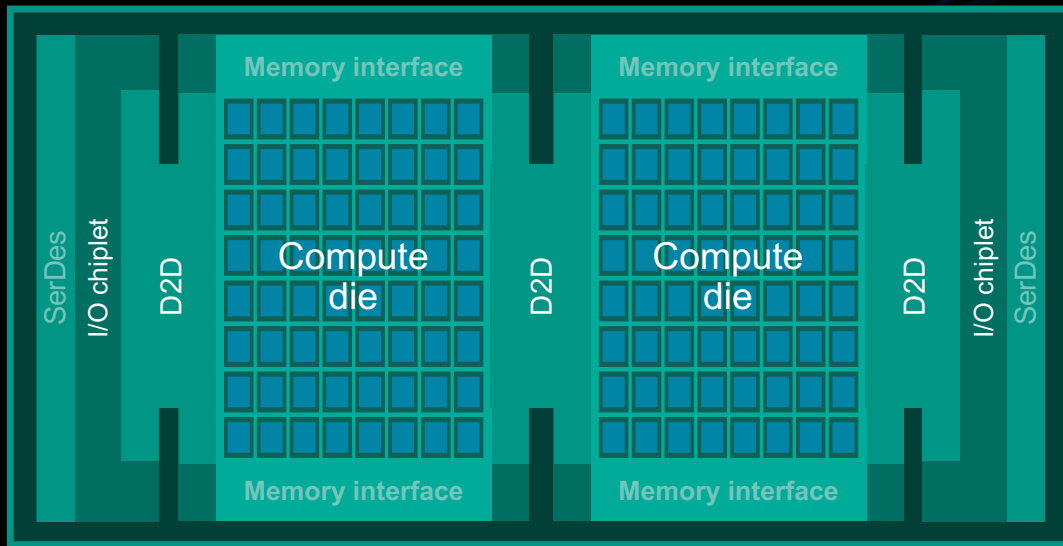
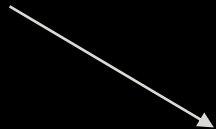

Custom AI Accelerator

Decades of experience
in building complex
compute SoCs

Advanced
package

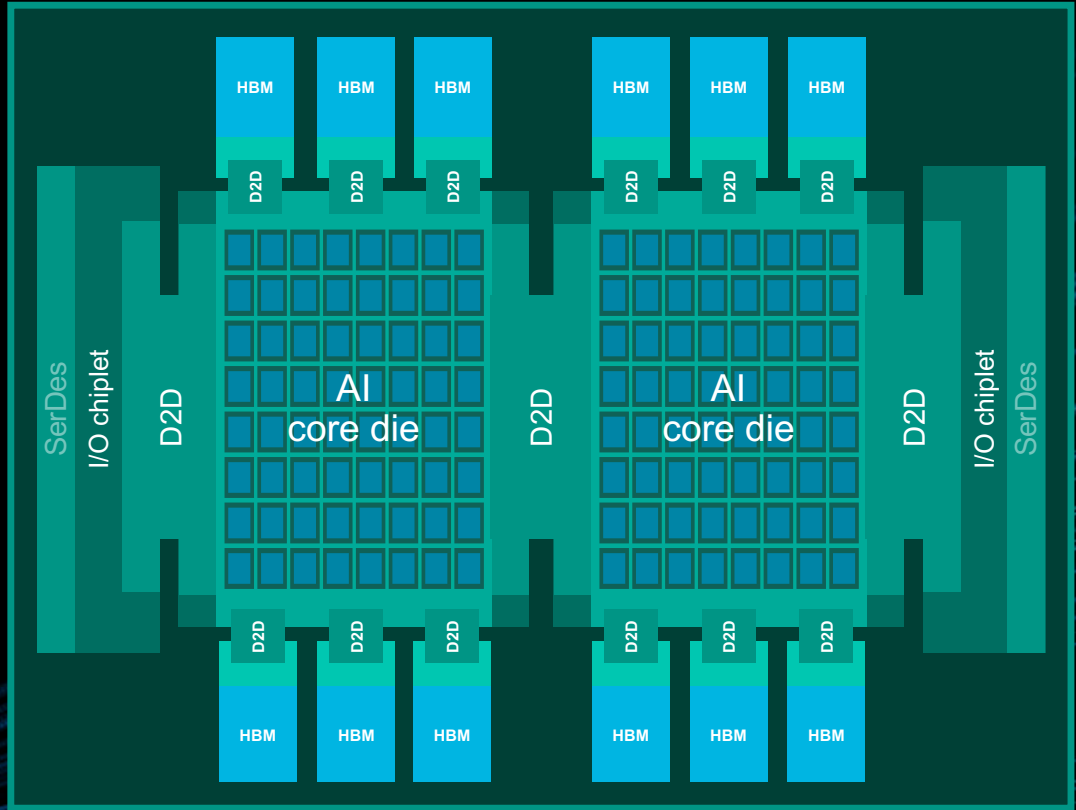
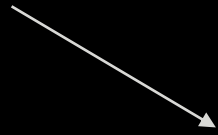

Expanding our AI customer base

Customer A

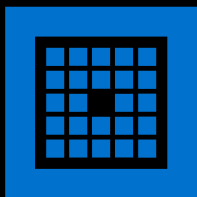

AI training
accelerator

Ramping now



AI inference
accelerator

CY2025 ramp

NEW!

Customer B



Arm
CPU

Ramping now

NEW!

Customer C



AI accelerator

CY2026 ramp

AI compute: 3 out of 4 U.S. hyperscale operators

Fast growing market, expanding share

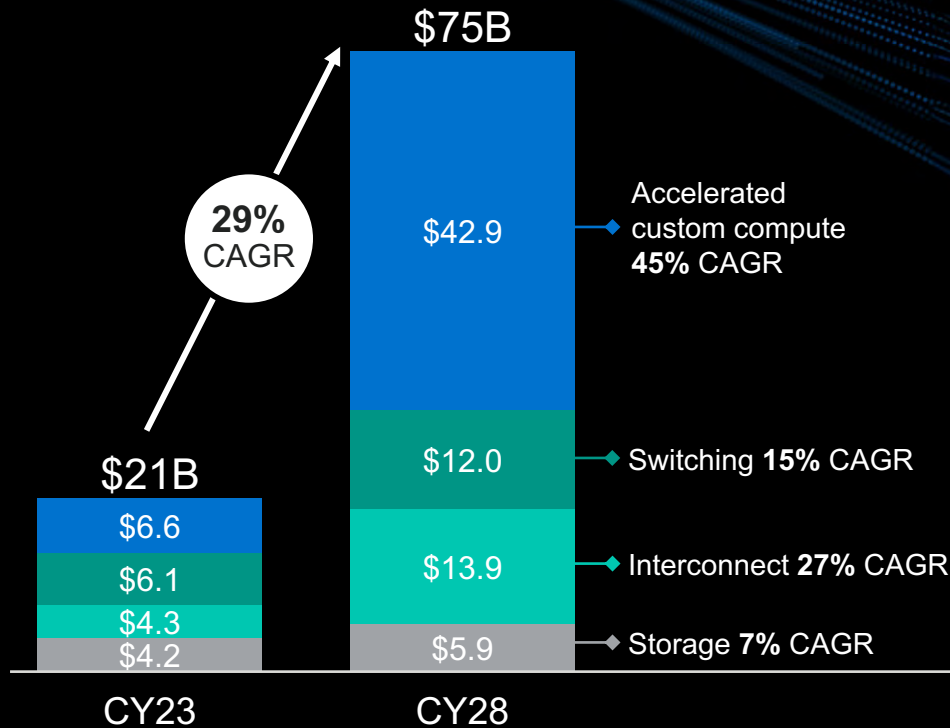

Last year: ~10% share	
End-market	Share expectations
Accelerated custom compute	Gain
Switching	Gain
Interconnect	Maintain
Storage	Maintain
Long-term target: 20% share	

Source: 650 Group, CignalAI, Dell'Oro, LightCounting, and Marvell estimates



Thank you



ACCELERATED INFRASTRUCTURE FOR THE AI ERA